

COLLECTIONS



PRESTIGE



La Maison THG Paris évoque à la fois l'artisanat et l'industrie française à son plus haut niveau. Avec son savoir-faire unique, la marque propose depuis plus de 60 ans des collections de robinetteries et d'accessoires de salle de bains d'exception.

L'excellence de ses produits permet à THG Paris de mériter son appellation de « Haute couture de la robinetterie ».

L'univers de THG Paris a pour vocation d'enrichir le design de la salle de bains en offrant des modèles de robinetteries aux styles bien différents. Chaque année, la maison surprend avec des collections remarquables.

En collaboration avec de prestigieuses marques de luxe ou imaginées par des créateurs de talent, les collections THG Paris font désormais partie de l'art de vivre à la française.

Je vous souhaite de belles découvertes.

Michel Gosse
Directeur Général THG Paris



The brand THG Paris provides both exquisite French craftsmanship and designs of the highest level. With its unique know-how, THG Paris offers more than sixty years of exceptional collections of bathroom fittings and accessories.

The excellence of its products gives THG Paris its recognition as “Haute Couture fittings”.

The world of THG Paris aims to enrich the design of bathroom fittings by offering models with very different styles. Every year, the house continues to surprise with absolutely remarkable collections.

In collaboration with prestigious luxury brands or imagined by talented creators, THG Paris collections are now part of the French art de vivre.

I hope you all enjoy the new designs.

Michel Gosse
THG Paris General Director

ANGE	13
DAHLIA	17
MASQUE DE FEMME	21
MÉTROPOLIS	25
MOSSI	29
NAÏADE	31
OCÉANIA	33
PANTHÈRE	35
PAPILLON	37
POMME	39
VENICE	41
INFINI	43
NIHAL	49
DRAGON	57
FLORE	63
GINKGO	67
ISLAND	71
PARADISE	75
ROSE	79
VÉGÉTAL	81
PÉTALE DE CRISTAL	83
MONTE CARLO	87
WEDDING	91
MALMAISON	95
CAPUCINE	99
ITHAQUE	103
MARQUISE	107
AMBOISE	111
AMOUR DE TRIANON	115
BAGATELLE	117
CHEVERNY	121
CYGNE	125
DIPLOMATE	127
DUOMO	131
JAIPUR	135
MANDARINE	139
NAJEM	145
SULLY	147
TÊTE DE LION	151
TROCADÉRO	153
VERSAILLES	157
VOGUE	159

COLLECTIONS

PRESTIGE

Les collections Prestige de THG Paris font partie de l'ADN de la maison. Habillées de pierres fines, de cristal ou encore de porcelaine, les robinetteries Prestige ont souvent une forme classique mais affichent une élégance rare. Les finitions dorées et or pâle s'accordent à merveille avec les designs prestigieux.

The Prestige collections from THG Paris are part of the company's DNA. Adorned by semi-precious stones, crystal or porcelain, Prestige bathroom fittings often have a classic shape but reveal a rare elegance. The gold or pale gold finishes go perfectly with the eminent designs.

PRESTIGE



Ange 13



Dahlia 17



Masque de Femme
métal lisse 22



Masque de Femme
métal gravé 22



Masque de Femme
solaire 22



Masque de Femme
lunaire 22



Métropolis cristal clair 26



Métropolis cristal noir 27



Mossi 29



Naïade 31



Océania 33



Panthère cristal clair 35



Panthère cristal noir 35



Papillon 37



Pomme cristal
clair lustré 39



Pomme cristal
doré lustré 39



Venice 41



Infini porcelaine
blanche 44



Infini porcelaine
décor platine 46



Infini porcelaine
décor or 47



Nihal porcelaine Ivoire
décor or 50



Nihal porcelaine bleue
décor platine 52



Nihal porcelaine noire
décor platine 53



Nihal métal 54



Nihal porcelaine verte
décor platine 55

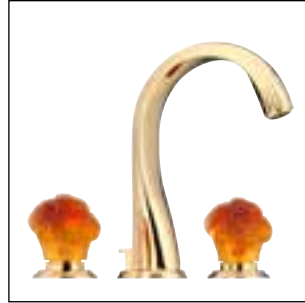

Dragon Sun 58



Dragon Jade 59



Dragon Moon 61



Flore 63



Ginkgo 67



Island 71



Paradise 75



Rose 79



Végétal 81



Pétale de cristal
liseré doré 84



Pétale de cristal clair 85



Pétale de cristal rouge 85



Pétale de cristal bleu 85



Pétale de cristal noir 85



Monte Carlo
porcelaine or 88

PRESTIGE



Monte Carlo
porcelaine or blanc 89



Wedding 91



Malmaison métal 96



Malmaison cristal 96



Malmaison Portoro 96



Malmaison Howlite 96



Capucine Mauve 100



Capucine vert 101



Ithaque doré 104



Ithaque platine 105

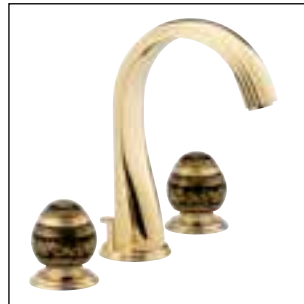

Marquise doré 108



Marquise platine 109



Amboise onyx noir 112



Amboise lapis lazuli 113



Amboise jaspe rouge 113



Amboise malachite 113

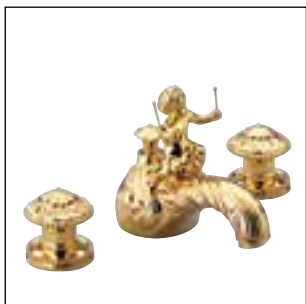

Amour de Trianon 115



Bagatelle pierre noire 118



Bagatelle métal 119



Cheverny lapis lazuli 122



Cheverny jaspe rouge 123



Cheverny malachite 123



Cheverny onyx noir 123



Cygne 125



Diplomate lisse 128



Diplomate annelé 128



Diplomate torsadé 128



Diplomate Royale 128



Duomo 132



Duomo cristal 133



Jaipur onyx noir 136



Jaipur cristal satiné 137



Jaipur métal 137



Mandarine métal 140



Mandarine cristal 141



Mandarine cristal satiné 142



Mandarine cristallia diamant 143



Najem 145



Sully onyx blanc 148



Sully onyx noir 148

PRESTIGE



Sully lapis lazuli 148



Sully malachite 148



Sully jaspe rouge 148



Tête de Lion 151



Trocadéro œil de tigre 154



Trocadéro lapis lazuli 155



Trocadéro jaspe rouge 155



Trocadéro malachite 155



Trocadéro onyx noir 155



Versailles 157



Vogue améthyste 160



Vogue lapis lazuli 161



Vogue onyx noir 161



Vogue malachite 161



Vogue jaspe rouge 161



Vogue œil de tigre 161

INDEX PAR CODE INDEX BY CODE

CODE	COLLECTION	PAGE
A1J	Amboise malachite	113
A1K	Amboise lapis lazuli	113
A1L	Amboise jaspe rouge	113
A1M	Amboise onyx noir	112
A1S	Cheverny malachite	123
A1T	Cheverny lapis lazuli	122
A1U	Cheverny jaspe rouge	123
A1V	Sully malachite	148
A1W	Sully lapis lazuli	148
A1X	Sully jaspe rouge	148
A2A	Métropolis cristal clair	26
A2B	Métropolis à manettes cristal clair	26
A2C	Océania	33
A2E	Venice	41
A2F	Naïade	31
A2G	Ange	13
A2H	Panthère cristal clair	35
A2J	Papillon	37
A2K	Panthère cristal noir	35
A2L	Métropolis cristal noir	27
A2M	Métropolis à manettes cristal noir	27
A2N	Mossi	29
A2R	Masque de Femme lunaire	22
A2S	Masque de Femme solaire	22
A2T	Masque de Femme métal gravé	22
A2U	Masque de Femme métal lisse	22
A41	Dahlia	17
A42	Pomme cristal clair lustré	39
A46	Pomme cristal doré lustré	39
A7A	Ithaque doré	104
A7B	Ithaque platine	105
A7D	Capucine Mauve	100
A7E	Capucine vert	101
A7F	Marquise doré	108
A7G	Marquise platine	109
A8B	Vogue améthyste	160
A8M	Vogue malachite	161
A8N	Vogue jaspe rouge	161
A8P	Vogue onyx noir	161
A8R	Vogue œil de tigre	161
A8S	Vogue lapis lazuli	161
A9B	Jaipur cristal satiné	137
A9C	Jaipur onyx noir	136
A9F	Jaipur métal	137
E53	Najem	145
G14	Versailles	157
G24	Amour de Trianon	115
G31	Cygne	125
G99	Tête de Lion	151
U1A	Mandarine métal	140

CODE	COLLECTION	PAGE
U1D	Mandarine cristal	141
U1E	Mandarine cristal satiné	142
U1K	Mandarine cristallia diamant	143
U1S	Sully onyx blanc	148
U1T	Sully onyx noir	148
U1V	Cheverny onyx noir	123
U2D	Infini porcelaine blanche	44
U2E	Infini porcelaine décor platine	46
U2F	Infini porcelaine décor or	47
U2L	Nihal porcelaine bleue décor platine	52
U2M	Nihal métal	54
U2N	Nihal porcelaine Ivoire décor or	50
U2P	Nihal porcelaine noire décor platine	53
U2R	Nihal porcelaine verte décor platine	55
U3A	Bagatelle métal	119
U3B	Bagatelle métal à manettes	119
U3E	Bagatelle pierre noire	118
U3F	Bagatelle pierre noire à manettes	118
U4A	Diplomate lisse	128
U4B	Diplomate annelé	128
U4C	Diplomate torsadé	128
U4D	Diplomate Royale	128
U4E	Duomo	132
U4F	Duomo cristal	133
U5A	Flore	63
U5B	Island	71
U5C	Paradise	75
U5D	Dragon Sun	58
U5E	Ginkgo	67
U5F	Végétal	81
U5G	Dragon Moon	61
U5H	Dragon Jade	59
U5J	Rose	79
U6A	Pétale de cristal clair	85
U6B	Pétale de cristal bleu	85
U6C	Pétale de cristal rouge	85
U6D	Pétale de cristal noir	85
U6E	Pétale de cristal liseré doré	84
U7A	Trocadéro malachite	155
U7B	Trocadéro lapis lazuli	155
U7C	Trocadéro jaspe rouge	155
U7D	Trocadéro onyx noir	155
U7E	Trocadéro œil de tigre	154
U8A	Wedding	91
U8B	Monte Carlo porcelaine or	88
U8C	Monte Carlo porcelaine or blanc	89
U93	Malmaison métal	96
U94	Malmaison cristal	96
U95	Malmaison Portoro	96
U97	Malmaison Howlite	96



COLLECTION

ANGE

Comme un voyage sur un lit de nuages...

La collection Ange met en lumière l'ornementation classique des angelots et le savoir-faire ancestral du travail du cristal de la Maison Lalique. Le motif Ange, délicat et subtil, semble flotter sur un lit de nuages pour transformer la salle de bains en un sanctuaire de relaxation.

Déclinée pour le lavabo, la douche et la baignoire avec une ligne d'accessoires coordonnés, cette série est disponible dans un large choix de finitions, parmi lesquelles le chrome, l'or, l'or pâle, le nickel, et de nombreuses finitions PVD.

Travel through a bed of clouds...

The Ange collection occupies a prominent space in THG Paris Collection, in collaboration with the premier French crystal house Lalique. Ange creates the experience of floating on a bed of clouds with angels using the precise art of bas-relief etched in the finest Lalique crystal with a series of charming cherubs inset along the cylindrical fitting.

Available for basins, showers and baths, with a line of coordinated accessories, this series is available in a wide choice of finishes, including chrome, gold, soft gold, nickel, PVD finishes.

COLLECTION

ANGE



Ref. A2G.151

Mélangeur de lavabo 3 trous
Rim mounted 3-hole basin mixer



Ref. A2G.504N
Anneau porte-serviette
Single towel ring



Ref. A2G.538AC
Porte-papier rouleau
Wall mounted WC paper holder



COLLECTION

DAHLIA

Un design Lalique revisité.

Dahlia est née du partenariat entre le célèbre cristallier français Lalique et THG Paris. Par son design, à la fois graphique et poétique, cette collection témoigne d'un style classique revisité. L'élément de cristal ornant cette robinetterie reprend celui de la boîte Dahlia, création originelle de René Lalique en 1931. C'est en utilisant une technique d'une grande précision que les artisans THG Paris au savoir faire ancestral et à la grande dextérité ont traduit cette création originale en une collection de robinetterie.

Déclinée pour le lavabo, la douche et la baignoire avec une ligne d'accessoires coordonnés, cette série est disponible dans un large choix de finitions, parmi lesquelles le chrome, l'or, l'or pâle, le nickel, et de nombreuses finitions PVD.

Both graphic and poetic, Dahlia offers classic design revisited.

Dahlia is the new line born out of the partnership between THG Paris and the renowned French crystal manufacturer Lalique. Both graphic and poetic, Dahlia is a classic design revisited. The crystal that adorns these bathroom fittings is a reworking of the Dahlia box, an original creation by René Lalique from 1931. Using a technique that requires great dexterity and precision, THG Paris' expert craftsmen have flawlessly translated this design into a series of bath fixtures and accessories.

Available for basins, showers and baths, with a line of coordinated accessories, this series is available in a wide choice of finishes, including chrome, gold, soft gold, nickel, PVD finishes.

COLLECTION

DAHLIA



Ref. A41.151

Mélangeur de lavabo 3 trous
Rim mounted 3-hole basin mixer



Ref. A41.504N

Anneau porte-serviette
Single towel ring



Ref. A41.538AC

Porte-papier rouleau
Wall mounted WC paper holder



Ref. A41.5400BE

Garniture pour mitigeur thermostatique
avec 2 robinets d'arrêt
Trim for thermostat with 2 valves



Ref. A41.514/60

Porte-serviette
Single towel rail



Ref. A41.536

Porte-verre
Tumbler



COLLECTION

MASQUE DE FEMME

Éclat précieux du cristal, profondeur du métal, douceur des courbes.

Les déclinaisons de cette collection, gravées, sculptées et colorées, révèlent autant de tempéraments et de personnalités féminines. Cette collection précieuse et forte, en collaboration avec Lalique, est une ode à la femme et au savoir-faire de la Maison cristallière ; que l'on retrouve notamment dans les salles de bains de la « Villa Lalique », hôtel particulier et prestigieux situé dans l'Est de la France.

Le modèle « Masque de Femme » faisait partie de la Fontaine Coutard et fut initialement créé par René Lalique le 30 mars 1935 pour la commande d'un client particulier, Monsieur Coutard.

Déclinée pour le lavabo, la douche et la baignoire avec une ligne d'accessoires coordonnés, cette série est disponible dans un large choix de finitions, parmi lesquelles le chrome, l'or, l'or pâle, le nickel, et de nombreuses finitions PVD.

The precious sparkle of crystal, the depth of metal, the softness of curves.

The engraved, sculpted and coloured versions of this collection reveal an array of female temperaments and personalities. This precious and powerful collection, in collaboration with Lalique, is an ode to women and the expertise of the crystal company, which can be found notably in the bathrooms of "Villa Lalique", a prestigious and sumptuous hotel located in the East of France.

The "Masque de Femme" model was part of the Fontaine Coutard and was originally created by René Lalique on 30th March 1935 for the order of a private customer, Mr. Coutard.

Available for basins, showers and baths, with a line of coordinated accessories, this series is available in a wide choice of finishes, including chrome, gold, soft gold, nickel, PVD finishes.

COLLECTION

MASQUE DE FEMME



Ref. A2T.151

Mélangeur de lavabo 3 trous
Métal gravé
Rim mounted 3-hole basin mixer
Engraved metal



Ref. A2S.151

Mélangeur de lavabo 3 trous
Solaire
Rim mounted 3-hole basin mixer
Solaire



Ref. A2R.151

Mélangeur de lavabo 3 trous
Lunaire
Rim mounted 3-hole basin mixer
Lunaire



Ref. A2U.151

Mélangeur de lavabo 3 trous
Métal lisse
Rim mounted 3-hole basin mixer
Smooth metal



Ref. A2U.514/60

Porte-serviette
Single towel rail



Ref. A2U.536

Porte-verre
Tumbler



Ref. A2U.504N

Anneau porte-serviette
Single towel ring



COLLECTION

MÉTROPOLIS

À la manière des bijoux et objets décoratifs que René Lalique aimait tant créer, la collection Métropolis reprend les motifs de l'Art Nouveau en y associant un style moderne et urbain à travers les cubes graphiques et métalliques des croisillons.

Déclinée pour le lavabo, la douche et la baignoire avec une ligne d'accessoires coordonnés, cette série est disponible dans un large choix de finitions, parmi lesquelles le chrome, l'or, l'or pâle, le nickel, et de nombreuses finitions PVD.

Geometric lines combined to the sophisticated Lalique crystal.

The iconic grape motif of the crystal sculpture, originally created by designer René Lalique in 1928, decorated the interiors of the Orient Express and evokes the texture and fluidity of water. The square shaped handles reveal crystal encased in precious metal.

Available for basins, showers and baths, with a line of coordinated accessories, this series is available in a wide choice of finishes, including chrome, gold, soft gold, nickel, PVD finishes.

COLLECTION

MÉTROPOLIS CRISTAL CLAIR



Ref. A2A.151

Mélangeur de lavabo 3 trous
Rim mounted 3-hole basin mixer



Ref. A2B.151

Mélangeur de lavabo 3 trous
Rim mounted 3-hole basin mixer



Ref. A2A.504N

Anneau porte-serviette
Single towel ring



Ref. A2A.514/60

Porte-serviette
Single towel rail

COLLECTION

MÉTROPOLIS CRISTAL NOIR



Ref. A2L.151

Mélangeur de lavabo 3 trous
Rim mounted 3-hole basin mixer



Ref. A2M.151

Mélangeur de lavabo 3 trous
Rim mounted 3-hole basin mixer



Ref. A2L.620

Porte-savon fil mural
Net soap dish



COLLECTION

MOSSI

Un design résolument moderne retranscrit grâce à un savoir-faire artisanal.

Connue pour une esthétique classique et un cristal très travaillé, la Maison Lalique innove à travers cette collection. Cette fois, THG Paris et la Maison Lalique se sont tournées vers une création résolument contemporaine et épurée tout en gardant la préciosité du cristal. Un bec et des croisillons en métal lisse alliés à des dômes de cristal clair dont la disposition symétrique apporte un souffle moderne à cette robinetterie.

Déclinée pour le lavabo, la douche et la baignoire avec une ligne d'accessoires coordonnés, cette série est disponible dans un large choix de finitions, parmi lesquelles le chrome, l'or, l'or pâle, le nickel, et de nombreuses finitions PVD.

A surprising contemporary collection created thanks to an ancestral expertise.

THG Paris' Mossi collection of bath basin fittings and coordinating accessories articulates nature's fluid lines by featuring simple forms and elegant materials. Mossi's fluid lines are accented gently by dew-drop shaped circular Lalique crystal pearls. This tasteful expression of bejeweled glamour is sure to surprise and delight.

Available for basins, showers and baths, with a line of coordinated accessories, this series is available in a wide choice of finishes, including chrome, gold, soft gold, nickel, PVD finishes.



Ref. A2N.151

Mélangeur de lavabo 3 trous
Rim mounted 3-hole basin mixer



Ref. A2N.41SG

Mélangeur de bain 3 trous mural
Wall mounted 3-hole bath mixer



Ref. A2N.504N

Anneau porte-serviette
Single towel ring



COLLECTION

 NAÏADE

Richesse du métal ouvragé et transparence délicate du cristal gravé.

Volontairement hauts et larges, les croisillons de cette collection mettent en valeur la création Lalique et THG Paris, telle une fresque. Le cachet Naïade, à l'origine en verre blanc, a été créé le 7 novembre 1930. Depuis 1951, il est réalisé en cristal satiné et cristal transparent.

Comme une illusion, une vague laisse apparaître une sirène de cristal. Être aquatique, fantastique et chimère des marins, cette naïade inspire poésie et voyage.

Déclinée pour le lavabo, la douche et la baignoire avec une ligne d'accessoires coordonnés, cette série est disponible dans un large choix de finitions, parmi lesquelles le chrome, l'or, l'or pâle, le nickel, et de nombreuses finitions PVD.

Sensual feel for an ode to femininity.

Naiade celebrates René Lalique's daring ode to femininity in this lush example of THG Paris' collaboration with the premier French crystal house. The satin finish of the water nymph's figure mimics the soft and sensual feel of skin while her form, sculpted in relief on the crystal handles, complete with beads of water adorning her long tresses and fluid sense of movement, further the ethereal feeling of the work. The clean, sinuous form of the faucet itself complements the theme perfectly to create a fixture with a hint of hidden magic ideal for the bath.

Available for basins, showers and baths, with a line of coordinated accessories, this series is available in a wide choice of finishes, including chrome, gold, soft gold, nickel, PVD finishes.



Ref. A2F.151

Mélangeur de lavabo 3 trous
Rim mounted 3-hole basin mixer



Ref. A2F.504N

Anneau porte-serviette
Single towel ring



COLLECTION

OCÉANIA

Fluidité des lignes, audace d'une sculpture de cristal.

Poséidon, dieu des océans, chevauche les ondes dans un char tiré par des hippocampes d'or. Une légende raconte que les étoiles de mer sont le reflet des étoiles célestes, restées prisonnières des flots. Scintillante, celle-ci a conservé la vibration particulière qui anime ses stellaires cousines.

Déclinée pour le lavabo, la douche et la baignoire avec une ligne d'accessoires coordonnés, cette série est disponible dans un large choix de finitions, parmi lesquelles le chrome, l'or, l'or pâle, le nickel, et de nombreuses finitions PVD.

Flawless translation of a legend.

Oceania demonstrates the elegance and luxury of THG Paris' Cristal de Lalique collection in collaboration with the premier French crystal house. The Oceania is a visually stunning depiction of the legend of the starfish, shimmering amidst gentle ocean waves, characterized by the fluid form of the arched spout, as a reflection of their mysterious counterparts in the night sky. Designed with impeccable standards of craftsmanship, Oceania's harmony of style exudes the lifelike splendor of these mysterious creatures through the flawless intricacies imbued into the satin crystal by the master craftsmen.

Available for basins, showers and baths, with a line of coordinated accessories, this series is available in a wide choice of finishes, including chrome, gold, soft gold, nickel, PVD finishes.



Ref. A2C.151

Mélangeur de lavabo 3 trous
Rim mounted 3-hole basin mixer



Ref. A2C.40G

Mélangeur de lavabo 3 trous mural
Wall mounted basin set



COLLECTION

PANTHÈRE

Audace d'une création féminine.

Féline et racée, élancée et élégante, rare et recherchée, la collection Panthère est à l'image de son nom ; une collection forte. Créée par Marie-Claude Lalique, cette panthère transcende le cristal et prend vie ; prête à bondir sur sa proie. Cette collaboration de la Maison cristallière et de THG Paris est un pari réussi.

Déclinée pour le lavabo, la douche et la baignoire avec une ligne d'accessoires coordonnés, cette série est disponible dans un large choix de finitions, parmi lesquelles le chrome, l'or, l'or pâle, le nickel, et de nombreuses finitions PVD.

Paradox of an audacious design.

The Panthere series displays the thoughtful sophistication of THG Paris' Cristal de Lalique collection in collaboration with the premier French crystal house. Clear or black crystal are adorned with masterful carvings of panthers. Designed by Marie-Claude Lalique, the fixture embodies the sensual power of the feline form. In preparation for the hunt, the cat's nimble silhouette is portrayed stalking through the grass, her strong musculature covered with crystal fur. Textured handles are topped with a smooth, delicate surface followed by the Lalique imprint etched in metal.

Available for basins, showers and baths, with a line of coordinated accessories, this series is available in a wide choice of finishes, including chrome, gold, soft gold, nickel, PVD finishes.



Ref. A2H.151

Mélangeur de lavabo 3 trous
Cristal clair
Rim mounted 3-hole basin mixer
Clear crystal



Ref. A2H.504N

Anneau porte-serviette
Cristal clair
Single towel ring
Clear crystal



Ref. A2K.151

Mélangeur de lavabo 3 trous
Cristal noir
Rim mounted 3-hole basin mixer
Black crystal



COLLECTION

PAPILLON

Fascination du designer pour une créature délicate.

Preuve de dextérité et d'un savoir-faire précieux, le cristal de la collection Papillon est d'une telle légèreté que le papillon semble s'envoler de la robinetterie. Le cristal clair a la particularité de mettre en valeur le savoir-faire Lalique à travers des détails sculptés.

Encore une fois, la collaboration entre la Maison Lalique et THG Paris parcourt le thème animalier avec poésie.

Déclinée pour le lavabo, la douche et la baignoire avec une ligne d'accessoires coordonnés, cette série est disponible dans un large choix de finitions, parmi lesquelles le chrome, l'or, l'or pâle, le nickel, et de nombreuses finitions PVD.

This collection represents the fascination with the delicate beauty of these creatures.

Papillon masterfully represents THG Paris' Cristal de Lalique collection, in collaboration with the premier French crystal house. One of the most widely depicted species in the world of fine jewellery, the butterfly's fluttering motion and intricate wing designs captivated René Lalique among others. The Papillon faucet represents Lalique's fascination with the delicate beauty of these creatures. The crystal butterflies sit atop the handles as if suspended in time, poised to take flight at any moment. Master craftsmen have accomplished the near impossible and captured both a sense of movement and fine detail.

Available for basins, showers and baths, with a line of coordinated accessories, this series is available in a wide choice of finishes, including chrome, gold, soft gold, nickel, PVD finishes.



Ref. A2J.151

Mélangeur de lavabo 3 trous
Rim mounted 3-hole basin mixer



Ref. A2J.514/60

Porte-serviette
Single towel rail



COLLECTION

POMME

À la demande de THG Paris, Lalique a créé une sculpture de cristal représentant une pomme. Cette série, qui illustre parfaitement le style contemporain-chic, est inspirée par les thèmes de la séduction, de la beauté et de la tentation. C'est autour d'un bec majestueux galbé à la perfection telle une branche d'arbre, que deux pommes de cristal semblent avoir été posées délicatement. En cristal clair satiné ou lustré or, la réalisation de ces pommes est le fruit d'un savoir-faire d'exception et d'un processus manuel parfaitement maîtrisé par la Maison Lalique.

Pomme is a clean, contemporary-chic bath collection formed in collaboration with the premier French crystal house Lalique. Its handles take the shape of apples, which can be finished in clear satin crystal or gold luster crystal. The collection is balanced by an intricately designed spout that resembles a branch, with concave curves on its sides in an architectural, modern form, creating an organic feeling of unity throughout the piece. In addition to requiring the most advanced skills to create each sculptural masterpiece, producing the gold luster tone requires a very special process conducted by Lalique's skilled craftsmen.



Ref. A42.151

Mélangeur de lavabo 3 trous
Cristal clair satiné
Rim mounted 3-hole basin mixer
Clear satin crystal

Design by Lalique



Ref. A42.5540BE

Garniture pour mitigeur thermostatique
avec inverseur 2 sorties et une sortie basse
Cristal clair satiné
Trim for thermostat 3 outlets (2-way diverter
with stop position and 1 stop valve)
Clear satin crystal

THG-PARIS.COM



Ref. A46.151

Mélangeur de lavabo 3 trous
Cristal lustré or
Rim mounted 3-hole basin mixer
Gold luster crystal



COLLECTION

VENICE

C'est inspirés par René Lalique et sa passion pour la nature, que la Maison cristallière et THG Paris ont créé cette collection. Ainsi, les représentations de sauterelles et d'un feuillage dynamique subliment le savoir-faire unique et originel de René Lalique, tout en s'inscrivant dans la modernité. La collection de robinetterie Venice est un voyage dans le temps.

Déclinée pour le lavabo, la douche et la baignoire avec une ligne d'accessoires coordonnés, cette série est disponible dans un large choix de finitions, parmi lesquelles le chrome, l'or, l'or pâle, le nickel, et de nombreuses finitions PVD.

The elegance of the forms, delicacy of the design and softness of satin crystal.

Reflections of our civilizations and cultures, the symbols have great importance as they open the mind to the unknown and the infinite.

The universal symbol of the birth of the world for ancestral civilisations, these crystal eggs are attractively adorned with chiselled decorations of crickets. This collection combines ancient beliefs and modern design.

Available for basins, showers and baths, with a line of coordinated accessories, this series is available in a wide choice of finishes, including chrome, gold, soft gold, nickel, PVD finishes.



Ref. A2E.151

Mélangeur de lavabo 3 trous
Rim mounted 3-hole basin mixer



Ref. A2E.504N

Anneau porte-serviette
Single towel ring



COLLECTION

INFINI

Infini, décor phare de la Maison Haviland, dévoile une gravure subtile, moderne et intemporelle inspirée du rayonnement solaire.

Modelée en creux à la main, la gravure Infini est fidèle à l'ADN de la manufacture française de porcelaine et révèle tout le savoir-faire du Maître porcelainier : exigence, excellence et minutie.

Déclinée pour le lavabo, la douche et la baignoire avec une ligne d'accessoires coordonnés, cette série est disponible dans un large choix de finitions, parmi lesquelles le chrome, l'or, l'or pâle, le nickel, et de nombreuses finitions PVD.

Infini, Haviland's most popular collection, reveals a subtle, modern and timeless engraving inspired by the rays of the sun. Created in counter-relief by hand, the Infini engraving is faithful to the DNA of the French porcelain factory and reveals all the know-how of the Master Porcelain maker: high standards, excellence and attention to detail.

Available for basins, showers and baths, with a line of coordinated accessories, this series is available in a wide choice of finishes, including chrome, gold, soft gold, nickel, PVD finishes.

COLLECTION

INFINI PORCELAIN
BLANCHE



Ref. U2D.151

Mélangeur de lavabo 3 trous
Rim mounted 3-hole basin mixer



Ref. U2D.5400BE

Garniture pour mitigeur thermostatique
avec 2 robinets d'arrêt
Trim for thermostat with 2 valves



Ref. U2D.54

Ensemble douchette mural
Wall mounted
handshower set



Ref. U2D.536

Porte-verre
Tumbler



Ref. U2D.500

Porte-savon
Soap dish



Ref. U2D.517

Porte-peignoir
Robe hook

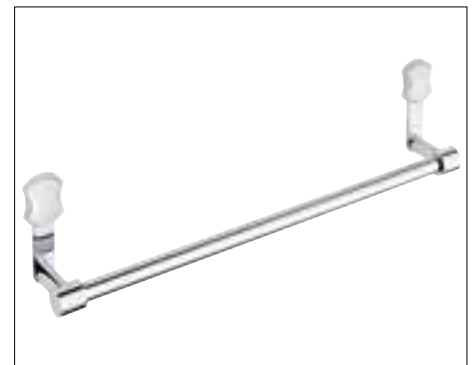

Ref. U2D.520/60

Porte-serviette
Single towel rail

COLLECTION

INFINI PORCELAIN DÉCOR PLATINE



Ref. U2E.151

Mélangeur de lavabo 3 trous
Rim mounted 3-hole basin mixer



Ref. U2E.1132SG

Porte-savon
Soap dish



Ref. U2E.5500BE

Garniture pour mitigeur thermostatique
avec inverseur 2 sorties
Trim for thermostat
with 2-way diverter



Ref. U2E.5540BE

Garniture pour mitigeur thermostatique
5540AE avec inverseur 2 sorties et une
sortie basse
Trim for thermostat 5540AE 3 outlets
(2-way diverter with stop position and 1
stop valve)

COLLECTION

INFINI PORCELAINE DÉCOR OR



Ref. U2F.151

Mélangeur de lavabo 3 trous
Rim mounted 3-hole basin mixer



COLLECTION

NIHAL

THG Paris, Xavier Cartron et Haviland mettent en commun leur savoir-faire pour cette collection exceptionnelle où la porcelaine se marie naturellement avec le métal.

Raffinement contemporain, volume et géométrie, évanescence, artisanat et tradition, croissant de lune, iridescence et délicatesse, couleur et fraîcheur... Nihal symbolise la source d'eau, elle est l'une des 4 étoiles de la constellation LEPUS. Une collection, qui tend vers un style interculturel résolument contemporain, qui s'orchestre en une géométrie subtile et évanescente.

Déclinée pour le lavabo, la douche et la baignoire avec une ligne d'accessoires coordonnés, cette série est disponible dans un large choix de finitions, parmi lesquelles le chrome, l'or, l'or pâle, le nickel, et de nombreuses finitions PVD.

THG Paris, Xavier Cartron and Haviland are mixing their know-how for this exceptional collection where porcelain matches naturally with metal.

Contemporary refinement, volume and geometry, evanescence, craftsmanship and tradition, crescent moon, iridescence and delicacy, color and freshness... Nihal symbolizes the source of water, it is one of the 4 stars of the LEPUS constellation. A collection, which tends towards a resolutely contemporary intercultural style, orchestrated in a subtle and evanescent geometry.

Available for basins, showers and baths, with a line of coordinated accessories, this series is available in a wide choice of finishes, including chrome, gold, soft gold, nickel, PVD finishes.

COLLECTION

NIHAL PORCELAIN IVOIRE DÉCOR OR



Ref. U2N.151

Mélangeur de lavabo 3 trous
Rim mounted 3-hole basin mixer



Ref. U2N.517

Porte-peignoir
Single robe hook



Ref. U2N.536

Porte-verre
Tumbler



Ref. U2N.1132SG

Mélangeur de bain avec douchette
alimentée par mitigeur progressif
Rim mounted bath mixer and handshower set
with single lever mixer



Ref. U2N.500

Porte-savon
Soap dish



Ref. U2N.84L + 281EP

Pomme de douche
 Ø 200 mm et bras mural
 Wall mounted shower head
 Ø 200 mm / 8" and arm



Ref. U2N.504N

Anneau porte-serviette
 Single towel ring



Ref. U2N.5400BE

Garniture pour mitigeur thermostatique THG
 Paris avec deux robinets d'arrêt réf. 5400AE
 Trim for thermostat with 2 valves ref. 5400AE
 with box for rough parts

COLLECTION

NIHAL PORCELAIN
BLEUE DÉCOR PLATINE



Ref. U2L.151

Mélangeur de lavabo 3 trous
Rim mounted 3-hole basin mixer

COLLECTION

NIHAL PORCELAIN
NOIRE DÉCOR PLATINE



Ref. U2P.151

Mélangeur de lavabo 3 trous
Rim mounted 3-hole basin mixer

COLLECTION

NIHAL MÉTAL



Ref. U2M.151

Mélangeur de lavabo 3 trous
Rim mounted 3-hole basin mixer

COLLECTION

NIHAL PORCELAIN
VERTE DÉCOR PLATINE



Ref. U2R.151

Mélangeur de lavabo 3 trous
Rim mounted 3-hole basin mixer



COLLECTION

DRAGON

Cristal coloré et inspiration asiatique.

La couleur du cristal est l'élément clé de cette collection créée en collaboration avec la Maison française Daum. Cette collection d'inspiration asiatique, reflète les différentes colorations, du lever au coucher du soleil.

Déclinée pour le lavabo, la douche et la baignoire avec une ligne d'accessoires coordonnés, cette série est disponible dans un large choix de finitions, parmi lesquelles le chrome, l'or, l'or pâle, le nickel, et de nombreuses finitions PVD.

Asian inspired coloured crystal.

The colour of the crystal is the key element of this collection created in collaboration with the French Daum company. This Asian inspired collection reflects the different colours from sunrise to sunset.

Available for basins, showers and baths, with a line of coordinated accessories, this series is available in a wide choice of finishes, including chrome, gold, soft gold, nickel, PVD finishes.



Ref. U5D.151

Mélangeur de lavabo 3 trous
Rim mounted 3-hole basin mixer

COLLECTION

DRAGON SUN



Ref. U5D.5840/8

Ensemble hygiénique
Hygienic set



Ref. U5D.41SG

Mélangeur de bain
3 trous mural
Wall mounted
3-hole bath mixer



Ref. U5D.1132SG

Mélangeur de bain avec douchette alimentée par mitigeur
Bath mixer + handshower set with single lever mixer



Ref. U5D.514/60

Porte-serviette
Single towel rail



Ref. U5D.84L + 286

Pomme de douche
Ø 200 mm et bras mural
Wall mounted shower head
Ø 200 mm / 8" and arm



Ref. U5D.5500BE

Garniture pour mitigeur
thermostatique avec inverseur
2 sorties
Trim for thermostat with 2-way
diverter



Ref. U5D.517

Porte-peignoir
Robe hook

COLLECTION

DRAGON JADE
**Ref. U5H.5840/8**

Ensemble hygiénique
Hygienic set

**Ref. U5H.40G**

Mélangeur de lavabo
3 trous mural
Wall mounted basin set

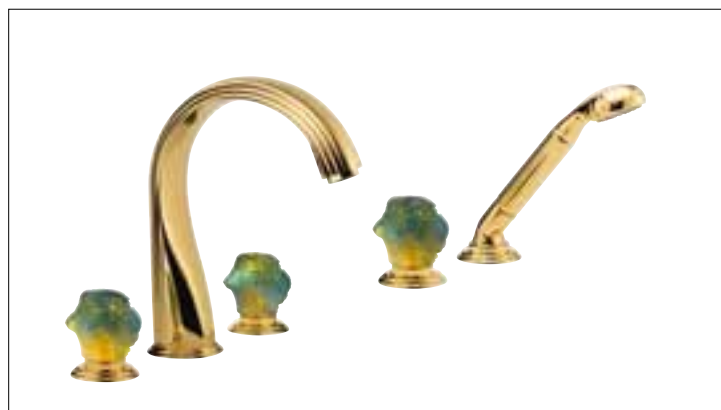
**Ref. U5H.1132SG**

Mélangeur de bain avec douchette alimentée par mitigeur
Bath mixer + handshower set with single lever mixer

**Ref. U5H.151**

Mélangeur de lavabo
3 trous
Rim mounted
3-hole basin mixer

**Ref. U5H.84L + 280EP**

Pomme Ø 300 mm avec
système Easyclean
et bras mural
Showerhead Ø 300 mm (12")
with Easyclean system
and showerarm

**Ref. U5H.504N**

Anneau porte-serviette
Single towel ring

**Ref. U5H.500**

Porte-savon
Soap dish



COLLECTION

DRAGON MOON



Ref. U5G.151

Mélangeur de lavabo 3 trous
Rim mounted 3-hole basin mixer



Ref. U5G.40G

Mélangeur de lavabo 3 trous mural
Wall mounted basin set



Ref. U5G.500

Porte-savon
Soap dish



Ref. U5G.536

Porte-verre
Tumbler



COLLECTION

FLORE

Plus qu'une robinetterie, cette collection emprunte un sujet et un savoir-faire artistique. Association d'un motif floral et d'une matière minérale, la collection Flore célèbre la beauté des fleurs à travers des incrustations uniques de cristal sculptés par la Maison Daum. Sujet cher à la joaillerie et à l'art, ces fleurs transcendent la robinetterie et apparaissent en sculptures poétiques.

Déclinée pour le lavabo, la douche et la baignoire avec une ligne d'accessoires coordonnés, cette série est disponible dans un large choix de finitions, parmi lesquelles le chrome, l'or, l'or pâle, le nickel, et de nombreuses finitions PVD.

More than just faucets, this collection borrows an artistic subject and know-how.

Combining a floral motif and a mineral material, the Flore collection celebrates the beauty of flowers through unique crystal inlays sculpted by the Daum company. A subject dear to jewellery and art, these flowers transcend the faucet fittings and appear as poetic sculptures. Available for basins, showers and baths, with a line of coordinated accessories, this series is available in a wide choice of finishes, including chrome, gold, soft gold, nickel, PVD finishes.

COLLECTION

FLORE



Ref. U5A.151

Mélangeur de lavabo 3 trous
Rim mounted 3-hole basin mixer



Ref. U5A.40G

Mélangeur de lavabo 3 trous mural
Wall mounted basin set



Ref. U5A.5840/8

Ensemble hygiénique
Hygienic set

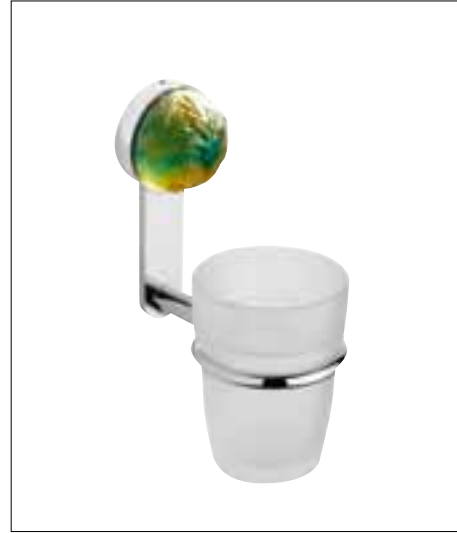

Ref. U5A.536

Porte-verre
Tumbler



Ref. U5A.514/60

Porte-serviette
Single towel rail



COLLECTION

GINKGO

Accord parfait pour une expérience sensorielle. Entre l'orange et la terre de Sienne, la couleur du cristal insuffle une dynamique au motif de cet arbre aux nombreuses vertus. Esthétique et toucher ont été pensés avec précision et intelligence pour une expérience sensitive. La collection Ginkgo révèle encore une fois le don de Daum pour le cristal sculpté et coloré, et apporte une nouvelle série à la collaboration réussie entre Daum et THG Paris.

Déclinée pour le lavabo, la douche et la baignoire avec une ligne d'accessoires coordonnés, cette série est disponible dans un large choix de finitions, parmi lesquelles le chrome, l'or, l'or pâle, le nickel, et de nombreuses finitions PVD.

A perfect match for a sensory experience.

Between Orange and Sienna earth hue, the colour of the crystal breathes dynamism into the motif of this tree with many virtues. The aesthetics and sens of touch have been designed with precision and intelligence for a sensory experience. The Ginkgo collection reveals once again Daum's gift for sculpted and coloured crystal, and adds a new series to the successful collaboration between Daum and THG Paris.

Available for basins, showers and baths, with a line of coordinated accessories, this series is available in a wide choice of finishes, including chrome, gold, soft gold, nickel, PVD finishes.



Ref. U5E.151

Mélangeur de lavabo 3 trous
Rim mounted 3-hole basin mixer

COLLECTION

GINKGO

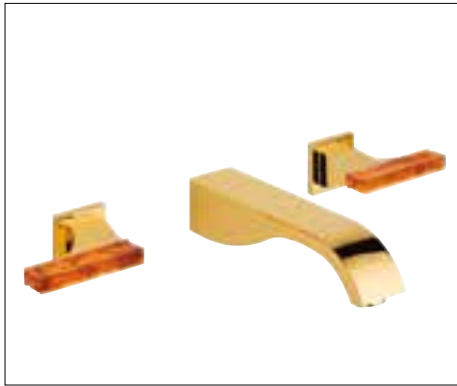

Ref. U5E.41SG

Mélangeur de bain 3 trous mural
Wall mounted 3-hole bath mixer



Ref. U5E.5100B

Garniture pour mitigeur thermostatique
Trim for thermostat



Ref. U5E.52

Ensemble douchette mural
Wall mounted
handshower set



Ref. U5E.504N

Anneau porte-serviette
Single towel ring



Ref. U5E.536

Porte-verre
Tumbler



Ref. U5E.500

Porte-savon
Soap dish



Ref. U5E.517

Porte-peignoir
Robe hook



COLLECTION

ISLAND

Quand une nature et une végétation luxuriante envahissent la salle de bains...

Luxuriante, colorée et presque fantastique, la nature de la collection Island se transporte et envahit la salle de bains. Avec paradoxe et subtilité, le cristal Daum apporte une touche chic à cette collection.

Déclinée pour le lavabo, la douche et la baignoire avec une ligne d'accessoires coordonnés, cette série est disponible dans un large choix de finitions, parmi lesquelles le chrome, l'or, l'or pâle, le nickel, et de nombreuses finitions PVD.

When nature and luxuriant vegetation sweep through the bathroom...

Luxuriant, colourful and almost fantastical, the nature of the Island collection is transported and sweeps through the bathroom. With paradox and subtlety, the Daum crystal brings a chic touch to this collection.

Available for basins, showers and baths, with a line of coordinated accessories, this series is available in a wide choice of finishes, including chrome, gold, soft gold, nickel, PVD finishes.



Ref. U5B.151

Mélangeur de lavabo 3 trous
Rim mounted 3-hole basin mixer

COLLECTION

ISLAND



Ref. U5B.41SG

Mélangeur de bain 3 trous mural
Wall mounted 3-hole bath mixer



Ref. U5B.1132SG

Mélangeur de bain avec douchette alimentée par mitigeur
Bath mixer + handshower set with single lever mixer



Ref. U5B.5100B

Garniture pour mitigeur thermostatique
Trim for thermostat



Ref. U5B.5500BE

Garniture pour mitigeur thermostatique
avec inverseur 2 sorties
Trim for thermostat
with 2-way diverter



Ref. U5B.504N

Anneau porte-serviette
Single towel ring



Ref. U5B.52
Ensemble douchette mural
Wall mounted
handshower set



Ref. U5B.500
Porte-savon
Soap dish



Ref. U5B.536
Porte-verre
Tumbler



COLLECTION

PARADISE

Rêverie et imagination, pour un voyage au Paradis.

Avec cette collection, Daum et THG Paris proposent une promenade dans le jardin d'Eden. La pâte de cristal se transforme en formes abstraites, une œuvre d'art, dans laquelle on imagine une faune et une flore luxuriante. Rêverie et imagination sont donc les maîtres-mots de cette collection.

Déclinée pour le lavabo, la douche et la baignoire avec une ligne d'accessoires coordonnés, cette série est disponible dans un large choix de finitions, parmi lesquelles le chrome, l'or, l'or pâle, le nickel, et de nombreuses finitions PVD.

Daydream and imagination, for a journey to Paradise.

With this collection, Daum and THG Paris offer a stroll in the garden of Eden. The crystal paste is transformed into abstract shapes, a work of art, in which one imagines luxuriant fauna and flora. Daydream and imagination are thus the watchwords for this collection.

Available for basins, showers and baths, with a line of coordinated accessories, this series is available in a wide choice of finishes, including chrome, gold, soft gold, nickel, PVD finishes.



Ref. U5C.151

Mélangeur de lavabo 3 trous
Rim mounted 3-hole basin mixer

COLLECTION

PARADISE



Ref. USC.1132SG

Mélangeur de bain avec douchette alimentée par mitigeur
Bath mixer + handshower set with single lever mixer



Ref. USC.5100BR

Garniture pour mitigeur thermostatique
Trim for thermostat



Ref. U5C.5400BE

Garniture pour mitigeur thermostatique
avec 2 robinets d'arrêt
Trim for thermostat with 2 valves



Ref. U5C.517

Porte-peignoir
Robe hook



Ref. U5C.520/60

Porte-serviette
Single towel rail



COLLECTION

ROSE

La Rose, est l'une des pièces cultes de la Maison Daum. Ici, elle a été délicatement déposée sur le métal travaillé de la robinetterie THG Paris. Ainsi, cette prestigieuse collection de couleur rose et ornée de cette fleur, amène douceur, romantisme et sensualité dans la salle de bains. Déclinée pour le lavabo, la douche et la baignoire avec une ligne d'accessoires coordonnés, cette série est disponible dans un large choix de finitions, parmi lesquelles le chrome, l'or, l'or pâle, le nickel, et de nombreuses finitions PVD.

For this collaboration, one of Daum brand's signature pieces - the Rose flower - has been delicately placed atop of THG Paris' metal faucets. These prestigious designs - "Rose" in both form and hue - will bring sweetness, romance and sensuality to your bathrooms. Available for basins, showers and baths, with a line of coordinated accessories, this series is available in a wide choice of finishes, including chrome, gold, soft gold, nickel, PVD finishes.



Ref. U5J.151

Mélangeur de lavabo 3 trous
Rim mounted 3-hole basin mixer



Ref. U5J.40G

Mélangeur de lavabo 3 trous mural
Wall mounted basin set



Ref. U5J.500

Porte-savon
Soap dish



COLLECTION

VÉGÉTAL

Paradoxe de l'association d'un métal lisse et graphique, et d'une végétation riche et abondante.

Cette collection en partenariat avec la Maison de cristallerie Daum magnifie le motif végétal, incontournable en décoration, à travers un travail de matière. À la fois translucide et givré, le cristal sublime l'utilitaire de la robinetterie.

Déclinée pour le lavabo, la douche et la baignoire avec une ligne d'accessoires coordonnés, cette série est disponible dans un large choix de finitions, parmi lesquelles le chrome, l'or, l'or pâle, le nickel, et de nombreuses finitions PVD.

The paradox of combining smooth and graphic metal with rich and abundant vegetation.

This collection, in partnership with Daum crystal company, glorifies the plant motif, essential in decoration, by working on the material. Both translucent and frosted, the crystal enhances the faucet utility.

Available for basins, showers and baths, with a line of coordinated accessories, this series is available in a wide choice of finishes, including chrome, gold, soft gold, nickel, PVD finishes.



Ref. U5F.151

Mélangeur de lavabo 3 trous
Rim mounted 3-hole basin mixer



Ref. U5F.5540BE

Garniture pour mitigeur thermostatique
avec inverseur 2 sorties et une sortie basse
Trim for thermostat 3 outlets (2-way
diverter with stop position and 1 stop valve)



Ref. U5F.52

Ensemble douchette mural
Wall mounted
handshower set



COLLECTION

PÉTALE DE CRISTAL

Association originale de savoir-faire.

La collection Pétale de Cristal est l'association originale des savoir-faire d'une Manufacture française, Baccarat, et d'un Maître robinetier de style, THG Paris. De cette rencontre est née une collection unique d'inspiration florale, dessinée par le designer Pierre-Yves Rochon. En imaginant cette collection, aux lignes pures et délicates, Pierre-Yves Rochon a subtilement réuni l'expertise unique des deux Maisons.

Déclinée en cristal clair ou de couleur : noir, rouge, bleu ou ornée d'un filet à l'or fin, cette collection inédite dans l'univers de la salle de bains reprend les codes incontournables de la Maison Baccarat.

An original collaboration between talents.

The "Pétale de Cristal" collection is an original collaboration between the talents of a French crystal manufacturer, Baccarat, and a stylish master faucet maker, THG Paris.

This encounter has given birth to a unique collection inspired by flowers, designed by Pierre-Yves Rochon. In imagining the "Pétale de Cristal" collection, with its pure and delicate lines, Pierre-Yves Rochon has subtly brought the unique expertise of these two houses together.

Available in clear or coloured crystal – black, red, blue or decorated with a fine gold thread – this brand new bathroom collection is guided by the fundamental codes of the House of Baccarat.



Ref. U6E.151

Mélangeur de lavabo 3 trous
Rim mounted 3-hole basin mixer



Ref. U6E.40G

Mélangeur de lavabo 3 trous mural
Wall mounted basin set

COLLECTION

PÉTALE DE CRISTAL LISERÉ DORÉ



Ref. U6E.5840/8

Ensemble hygiénique
Hygienic set



Ref. U6E.2155

Mélangeur de lavabo
One-hole basin mixer



Ref. U6E.5100B

Garniture pour mitigeur
thermostatique
Trim for thermostat



Ref. U6E.5500BE

Garniture pour mitigeur
thermostatique
avec inverseur 2 sorties
Trim for thermostat
with 2-way diverter



Ref. U6E.500

Porte-savon
Soap dish



Ref. U6E.536

Porte-verre
Tumbler



Ref. U6E.546GM

Coupe porte-savon
Soap dish



Ref. U6E.504N

Anneau porte-serviette
Single towel ring

COLLECTION

PÉTALE DE CRISTAL



Ref. U6A.151

Mélangeur de lavabo 3 trous
Cristal clair
Rim mounted 3-hole basin mixer
Clear crystal



Ref. U6B.151

Mélangeur de lavabo 3 trous
Cristal bleu
Rim mounted 3-hole basin mixer
Blue crystal



Ref. U6D.151

Mélangeur de lavabo 3 trous
Cristal noir
Rim mounted 3-hole basin mixer
Black crystal



Ref. U6C.151

Mélangeur de lavabo 3 trous
Cristal rouge
Rim mounted 3-hole basin mixer
Red crystal



COLLECTION

MONTE CARLO

Collaboration avec une Manufacture royale pour une luxueuse collection.

THG Paris a créé une série très luxueuse en collaboration avec la Manufacture de Monaco, célèbre porcelainier qui a l'immense privilège d'arbore le titre officiel de « Fournisseur breveté de S.A.S. le Prince de Monaco ». Cette série, nommée « Monte Carlo » d'un style chic-baroque, témoigne du savoir-faire incontestable de ces entreprises de renom. En effet, la Manufacture de Monaco sculpte les croisillons en porcelaine en utilisant une technique très pointue et très différente des techniques traditionnelles. On parle d'incrustation, ce qui consiste à creuser la porcelaine pour faire apparaître le motif ; l'or mat jaune ou blanc, à 24 carats est ensuite appliqué en trois couches avec une cuisson entre chaque étape. La dernière étape consiste à insérer délicatement un à un les cristaux baguettes Swarovski.

Déclinée pour le lavabo, la douche et la baignoire avec une ligne d'accessoires coordonnés, cette série est disponible dans un large choix de finitions, parmi lesquelles le chrome, l'or, l'or pâle, le nickel, et de nombreuses finitions PVD.

Collaboration with a Royal Manufacture for a luxurious collection.

THG Paris has created a very luxurious series of fittings in collaboration with the Manufacture de Monaco, famous porcelain maker with the immense privilege of bearing the official title of "Purveyor by appointment to HRH Prince of Monaco". The "Monte Carlo" series in chic-baroque style, reflects the indisputable expertise of these renowned companies. Indeed, Manufacture de Monaco carves porcelain crosses using a very detailed and distinct technique to traditional techniques. We are talking overlay, which involves working into the porcelain to bring out the pattern; 24 carat matt gold, in yellow or white, is then applied in three layers with annealing between each step. The final step is to insert delicately, one-by-one the crystal Swarovski chopsticks.

Available for basins, showers and baths, with a line of coordinated accessories, this series is available in a wide choice of finishes, including chrome, gold, soft gold, nickel, PVD finishes.

COLLECTION

MONTE CARLO
PORCELAINE OR



Ref. U8B.151

Mélangeur de lavabo 3 trous
Rim mounted 3-hole
basin mixer



Ref. U8B.152

Mélangeur de lavabo 3 trous
Bec haut
Rim mounted 3-hole
basin mixer High spout



Ref. U8B.5840/8

Ensemble hygiénique
Hygienic set



Ref. U8B.5400BE

Garniture pour mitigeur
thermostatique
avec 2 robinets d'arrêt
Trim for thermostat with 2 valves



Ref. U8B.40G

Mélangeur de lavabo 3 trous mural
Wall mounted basin set



Ref. U8B.536

Porte-verre
Tumbler



Ref. U8B.510A

Porte-peignoir double
Double robe hook

COLLECTION

MONTE CARLO PORCELAIN OR BLANC



Ref. U8C.151

Mélangeur de lavabo 3 trous
Rim mounted 3-hole basin
mixer



Ref. U8C.152

Mélangeur de lavabo 3 trous
Bec haut
Rim mounted 3-hole basin
mixer - High spout



Ref. U8C.112BG

Mélangeur bain-douche 4 trous
Rim mounted 4-hole bath-shower mixer



Ref. U8C.5500BE

Garniture pour mitigeur
thermostatique avec
inverseur 2 sorties
Trim for thermostat
with 2-way diverter



Ref. U8C.514/60

Porte-serviette
Single towel rail



Ref. U8C.504N

Anneau porte-serviette
Single towel ring



Ref. U8C.500

Porte-savon
Soap dish



Ref. U8C.517

Porte-peignoir
Robe hook



COLLECTION

WEDDING

Des lignes contemporaines, le mariage de la porcelaine et du cristal pour une robinetterie bijou.

THG Paris a créé une série très luxueuse en collaboration avec la Manufacture de Monaco, célèbre porcelainier qui a l'immense privilège d'arbore le titre officiel de « Fournisseur breveté de S.A.S. le Prince de Monaco ». Présents dans de nombreux pays, les porcelaines monégasques sont très appréciées pour leur particularité et leur style unique. Cette série nommée « Wedding », d'un style contemporain-chic, témoigne du savoir-faire incontestable de ces entreprises de renom. Symbolisant le mariage de la porcelaine ornée d'une voie lactée de cristaux transparents Swarovski avec un bec aux lignes fluides et épurées finement travaillé par les artisans THG Paris, Wedding apporte luxe et modernité à la salle de bains. Les multiples facettes des cristaux délicatement apposés sur les croisillons en porcelaine blanche et platine reflètent la lumière avec une grande douceur. Ainsi paré, le robinet se transforme en un véritable bijou...

Déclinée pour le lavabo, la douche et la baignoire avec une ligne d'accessoires coordonnés, cette série est disponible dans un large choix de finitions, parmi lesquelles le chrome, l'or, l'or pâle, le nickel, et de nombreuses finitions PVD.

Contemporary lines, the marriage of porcelain and crystal for a jewel-like faucet.

THG Paris has created a very luxurious series in partnership with renowned porcelain manufacturer Manufacture de Monaco, which has the immense privilege of bearing the official title of "Purveyor by appointment to HRH Prince of Monaco". With a presence in many countries, Monegasque porcelains are highly valued for their distinctive, unique style. The Wedding series in chic-contemporary style, reflects the indisputable expertise of these renowned companies. Symbolising the marriage of ornate porcelain decorated with a milky way of clear Swarovski crystals and a spout in fluid lines, finely crafted by THG Paris' craftsmen, "Wedding" brings luxury and modernity to the bathroom. The multifaceted crystals gently affixed to the white and platinum porcelain crosses reflect light with great gentleness. Thus adorned, faucets become a real jewel...

Available for basins, showers and baths, with a line of coordinated accessories, this series is available in a wide choice of finishes, including chrome, gold, soft gold, nickel, PVD finishes.

COLLECTION

WEDDING



Ref. U8A.151

Mélangeur de lavabo 3 trous
Rim mounted 3-hole basin mixer



Ref. U8A.41SG

Mélangeur de bain 3 trous mural
Wall mounted 3-hole bath mixer



Ref. U8A.5100BR

Garniture pour mitigeur thermostatique
Trim for thermostat



Ref. U8A.5500BE

Garniture pour mitigeur thermostatique
avec inverseur 2 sorties
Trim for thermostat with 2-way diverter



Ref. U8A.1132SG

Mélangeur de bain avec douchette alimentée par mitigeur
Bath mixer + handshower set with single lever mixer



Ref. U8A.536

Porte-verre
Tumbler



Ref. U8A.520/60

Porte-serviette
Single towel rail



Ref. U8A.504N

Anneau porte-serviette
Single towel ring



COLLECTION

MALMAISON

Création originale et historique issue du partenariat entre deux Maisons françaises, Christofle et THG Paris.

Parmi les premières créations de THG Paris en partenariat avec la Maison Christofle, la collection Malmaison emprunte et réinvente les codes du style Empire. Métal sculpté, motifs inspirés de l'architecture romaine, et cristal, cette collection opulente et iconique apporte du caractère à la salle de bains.

Déclinée pour le lavabo, la douche et la baignoire avec une ligne d'accessoires coordonnés, cette série est disponible dans un large choix de finitions, parmi lesquelles le chrome, l'or, l'or pâle, le nickel, et de nombreuses finitions PVD.

An original and historical creation resulting from the partnership between two French companies, Christofle and THG Paris.

Among the first creations of THG Paris, in partnership with the Christofle company, the Malmaison collection uses and reinvents the Empire style codes. Sculpted metal, patterns inspired by Roman architecture, and crystal, this opulent and iconic collection gives the bathroom real character.

Available for basins, showers and baths, with a line of coordinated accessories, this series is available in a wide choice of finishes, including chrome, gold, soft gold, nickel, PVD finishes.

COLLECTION

MALMAISON



Ref. U93.151

Mélangeur de lavabo 3 trous
Métal
Rim mounted 3-hole basin mixer
Metal



Ref. U94.151

Mélangeur de lavabo 3 trous
Cristal
Rim mounted 3-hole basin mixer
Crystal



Ref. U95.151

Mélangeur de lavabo 3 trous
Portoro
Rim mounted 3-hole basin mixer
Portoro



Ref. U97.151

Mélangeur de lavabo 3 trous
Howlite
Rim mounted 3-hole basin mixer
Howlite



Ref. U93.514/60

Porte-serviette
Single towel rail

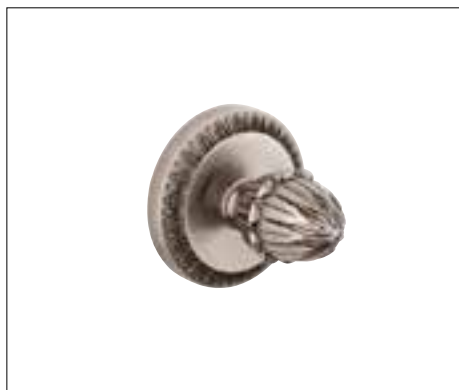

Ref. U93.517

Porte-peignoir
Robe hook



Ref. U93.504N

Anneau porte-serviette
Single towel ring



COLLECTION

CAPUCINE

Représentation classique et élégante d'un savoir-faire exceptionnel.

Motif décoratif emblématique de la Manufacture de Porcelaine Bernardaud, la collection Capucine incarne l'excellence et le savoir-faire des Maisons françaises Bernardaud et THG Paris. Le motif, envol de papillons, transcende cette représentation classique pour refléter la beauté de la nature.

Déclinée pour le lavabo, la douche et la baignoire avec une ligne d'accessoires coordonnés, cette série est disponible dans un large choix de finitions, parmi lesquelles le chrome, l'or, l'or pâle, le nickel, et de nombreuses finitions PVD.

Classic and elegant representation of exceptional craftsmanship.

Emblematic decorative motif of the Bernardaud Porcelain Factory, the Capucine collection embodies the excellence and know-how of French companies Bernardaud and THG Paris. The motif, a flight of butterflies, transcends this classic representation to reflect the beauty of nature.

Available for basins, showers and baths, with a line of coordinated accessories, this series is available in a wide choice of finishes, including chrome, gold, soft gold, nickel, PVD finishes.

COLLECTION

CAPUCINE MAUVE



Ref. A7D.151

Mélangeur de lavabo 3 trous
Rim mounted 3-hole basin mixer



Ref. A7D.112BSG

Mélangeur bain-douche 4 trous
Rim mounted 4-hole bath-shower mixer



Ref. A7D.41SG

Mélangeur de bain 3 trous mural
Wall mounted 3-hole bath mixer



Ref. A7D.4607

Porte-savon en porcelaine
Porcelain soap dish

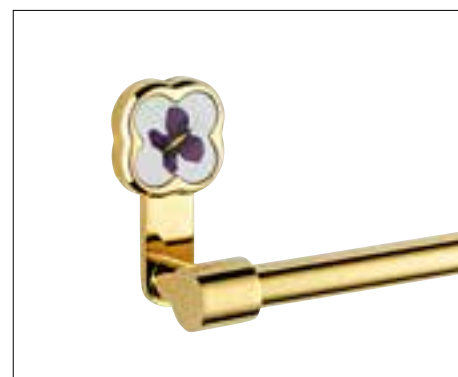

Ref. A7D.520/60

Porte-serviette
Single towel rail

COLLECTION

CAPUCINE VERT



Ref. A7E.151

Mélangeur de lavabo 3 trous
Rim mounted 3-hole basin
mixer



Ref. A7E.3202

Mélangeur de bidet
One-hole bidet mixer



Ref. A7E.6500

Mitigeur de lavabo
Single lever basin mixer



Ref. A7E.13B

Mélangeur bain-douche
mural
Wall mounted 2-hole bath-
shower mixer



Ref. A7E.4610

Pot à pinceaux en
porcelaine
Porcelain make-up
paintbrush pot



Ref. A7E.4613

Plateau en porcelaine
17 x 15 cm
Porcelain tray 17x15 cm



Ref. A7E.546GM

Coupe porte-savon
Soap dish



Ref. A7E.504N

Anneau porte-serviette
Single towel ring



COLLECTION

ITHAQUE

Un classique empreint de modernité.

Empruntée à l'art de la table Bernardaud, cette collection allie le paradoxe de l'élégance classique, presque historique et la modernité de la pureté. L'éclatante porcelaine blanche Bernardaud s'associe au doré ou au platine au travers de la robinetterie et des accessoires.

Déclinée pour le lavabo, la douche et la baignoire avec une ligne d'accessoires coordonnés, cette série est disponible dans un large choix de finitions, parmi lesquelles le chrome, l'or, l'or pâle, le nickel, et de nombreuses finitions PVD.

A classic full of modernity.

Borrowed from Bernardaud tableware, this collection combines the paradox of classic elegance, almost historic, and modern purity. The sparkling white Bernardaud porcelain adorns perfectly gold or platinum faucet fittings and accessories.

Available for basins, showers and baths, with a line of coordinated accessories, this series is available in a wide choice of finishes, including chrome, gold, soft gold, nickel, PVD finishes.



Ref. A7A.151

Mélangeur de lavabo 3 trous
Rim mounted 3-hole basin mixer

COLLECTION

ITHAQUE DORÉ



Ref. A7A.2155

Mélangeur de lavabo
Rim mounted one-hole
basin mixer



Ref. A7A.41SG

Mélangeur de bain
3 trous mural
Wall mounted
3-hole bath mixer



Ref. A7A.5500BE

Garniture pour mitigeur
thermostatique
avec inverseur 2 sorties
Trim for thermostat
with 2-way diverter



Ref. A7A.504N

Anneau porte-serviette
Single towel ring



Ref. A7A.4614

Plateau en porcelaine
22 x 20 cm
Porcelain tray 22x20 cm



Ref. A7A.4615

Coupele en porcelaine
Porcelain soap dish



Ref. A7A.538AC

Porte-papier rouleau
Wall mounted WC paper
holder



Ref. A7A.4621

Boîte en bois peinte
en laque de Chine
avec couvercle en porcelaine
Wooden box coated
with Chinese lacquer
with a porcelain lid

COLLECTION

ITHAQUE PLATINE



Ref. A7B.151

Mélangeur de lavabo 3 trous
Rim mounted 3-hole basin
mixer



Ref. A7B.52

Ensemble douchette mural
Wall mounted
handshower set



Ref. A7B.1132SG

Mélangeur de bain avec douchette
alimentée par mitigeur
Bath mixer + handshower set
with single lever mixer



Ref. A7B.510

Porte-peignoir
Robe hook



Ref. A7B.620

Porte-savon fil mural
Net soap dish



Ref. A7B.4607

Porte-savon en porcelaine
Porcelain soap dish



Ref. A7B.4611

Pot en porcelaine
Porcelain jar



COLLECTION

MARQUISE

Parfaite traduction du style royal français. C'est du partenariat des deux Maisons françaises, Bernardaud pour la porcelaine et THG Paris pour la robinetterie, qu'est née cette collection qui s'attache à reproduire les motifs historiques du style français du XVII^e et XVIII^e siècle. La collection Marquise, déclinée en platine et en doré, est un petit morceau de l'histoire de France.

Déclinée pour le lavabo, la douche et la baignoire avec une ligne d'accessoires coordonnés, cette série est disponible dans un large choix de finitions, parmi lesquelles le chrome, l'or, l'or pâle, le nickel, et de nombreuses finitions PVD.

A perfect reflection of the French royal style.

This collection was born out of the partnership of two French companies, Bernardaud for the porcelain and THG Paris for the faucet fittings, and attempts to reproduce the historical motifs of the French style of the XVIIth and of the XVIIIth centuries. The Marquise collection, available in platinum and gold, provides a small piece of French history.

Available for basins, showers and baths, with a line of coordinated accessories, this series is available in a wide choice of finishes, including chrome, gold, soft gold, nickel, PVD finishes.

COLLECTION

MARQUISE DORÉ



Ref. A7F.151

Mélangeur de lavabo 3 trous
Rim mounted 3-hole
basin mixer

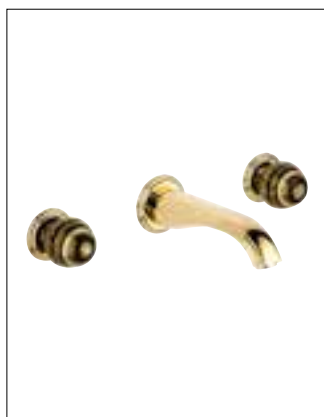

Ref. A7F.40G

Mélangeur de lavabo 3 trous
mural
Wall mounted basin set



Ref. A7F.516/60

Porte-serviettes 2 barres
Double towel rails



Ref. A7A.538AC

Porte-papier rouleau
Wall mounted WC
paper holder



Ref. A7F.2620

Porte-savon et porte-
éponge mural
Combined soap and sponge
dish



Ref. A7F.4608

Pot à pinceaux en porcelaine
Porcelain make-up
paintbrush pot



Ref. A7F.4623

Boîte en bois peinte
en laque de Chine
avec couvercle en porcelaine
Wooden box coated
with Chinese lacquer
with a porcelain lid

COLLECTION

MARQUISE PLATINE



Ref. A7G.151

Mélangeur de lavabo 3 trous
Rim mounted 3-hole
basin mixer



Ref. A7G.2155

Mélangeur de lavabo
One-hole basin mixer



Ref. A7G.514/60

Porte-serviette
Single towel rail



Ref. A7G.504N

Anneau porte-serviette
Single towel ring



Ref. A7G.4612

Plateau en porcelaine
12 x 11 cm
Porcelain tray 12x11 cm



Ref. A7G.4608

Pot à pinceaux en porcelaine
Porcelain make-up
paintbrush pot



Ref. A7G.4611

Pot en porcelaine
Porcelain jar



COLLECTION

AMBOISE

Une élégance classique pour une collection unique et personnalisable.

Rondeurs et pierres semi-précieuses, Amboise est l'élégance classique. Composée de deux dômes de cristal taillés en arc, la parure Amboise est d'autant plus unique qu'elle est personnalisable en plusieurs couleurs de pierres telles que lapis lazuli, onyx noir, malachite et jaspe rouge.

Déclinée pour le lavabo, la douche et la baignoire avec une ligne d'accessoires coordonnés, cette série est disponible dans un large choix de finitions, parmi lesquelles le chrome, l'or, l'or pâle, le nickel, et de nombreuses finitions PVD.

Classic elegance for a unique and customisable collection.

Rounded forms and semi-precious stones, Amboise is classic elegance. Composed of two domes of crystal cut in an arc, the Amboise set is all the more unique by being customisable in several colours of stones such as lapis lazuli, black Onyx, malachite and red Jasper.

Available for basins, showers and baths, with a line of coordinated accessories, this series is available in a wide choice of finishes, including chrome, gold, soft gold, nickel, PVD finishes.

COLLECTION

AMBOISE ONYX NOIR



Ref. A1M.151

Mélangeur de lavabo 3 trous
onyx noir
Rim mounted 3-hole basin mixer
black onyx



Ref. A1M.40G

Mélangeur de lavabo 3 trous mural
onyx noir
Wall mounted basin set
black onyx



Ref. A1M.2155

Mélangeur de lavabo
onyx noir
One-hole basin mixer
black onyx



Ref. A1M.5100B

Garniture pour mitigeur thermostatique
onyx noir
Trim for thermostat
black onyx

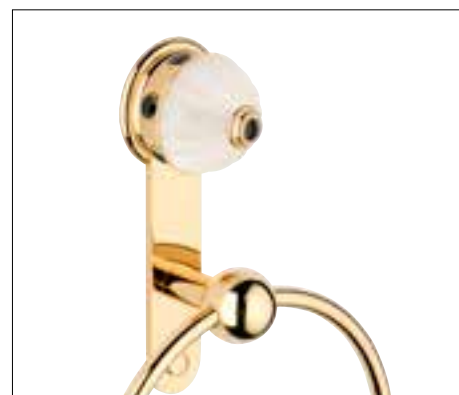

Ref. A1M.504N

Anneau porte-serviette
onyx noir
Single towel ring
black onyx

COLLECTION

AMBOISE



Ref. A1L.151

Mélangeur de lavabo 3 trous
jaspe rouge
Rim mounted 3-hole basin mixer
red jasper



Ref. A1K.151

Mélangeur de lavabo 3 trous
lapis lazuli
Rim mounted 3-hole basin mixer
lapis lazuli



Ref. A1J.151

Mélangeur de lavabo 3 trous
malachite
Rim mounted 3-hole basin mixer
malachite



Ref. A1J.5400BE

Garniture pour mitigeur thermostatique
avec 2 robinets d'arrêt
malachite
Trim for thermostat
with 2 valves
malachite



COLLECTION

AMOUR DE TRIANON

Rêverie et poésie pour une collection aux lignes uniques.

Angélique et poétique, cette collection est inspirée du petit paradis de Marie-Antoinette. Amour de Trianon transformera votre salle de bains en un lieu de rêverie et d'évasion.

Déclinée pour le lavabo, la douche et la baignoire avec une ligne d'accessoires coordonnés, cette série est disponible dans un large choix de finitions, parmi lesquelles le chrome, l'or, l'or pâle, le nickel, et de nombreuses finitions PVD.

Daydream and poetry for a collection with unique lines.

Angelic and poetic, this collection is inspired by Marie-Antoinette's little paradise. Amour de Trianon will transform your bathroom into a place of daydream and escape.

Available for basins, showers and baths, with a line of coordinated accessories, this series is available in a wide choice of finishes, including chrome, gold, soft gold, nickel, PVD finishes.

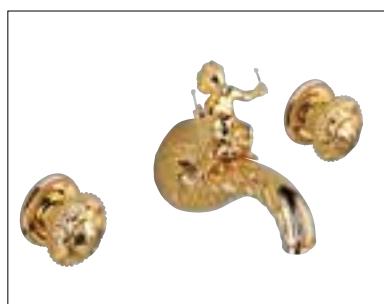

Ref. G24.40N

Mélangeur de lavabo 3 trous
mural
Wall mounted basin set



Ref. G24.112B

Mélangeur bain-douche 4 trous
Rim mounted 4-hole bath-shower
mixer

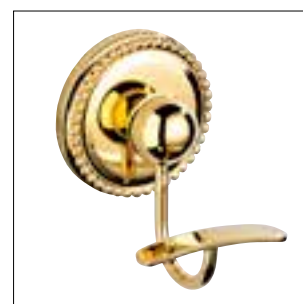

Ref. G24.510

Porte-peignoir
Robe hook

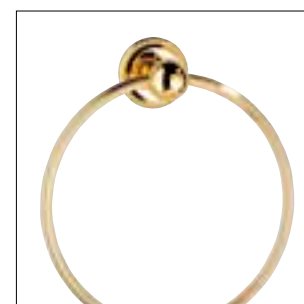

Ref. G24.504N

Anneau porte-serviette
Single towel ring



COLLECTION

BAGATELLE

Une collection caméléon par un grand nom du design.

La collection Bagatelle est née de la collaboration entre le designer Olivier Gagnère et THG Paris. Allure végétale en métal ou esprit dandy en pierre noire, cette collection caméléon s'adapte à tous les intérieurs.

Déclinée en métal et en pierre semi-précieuse pour le lavabo, la douche et la baignoire avec une ligne d'accessoires coordonnés, cette série est disponible dans un large choix de finitions, parmi lesquelles le chrome, l'or, l'or pâle, le nickel, et de nombreuses finitions PVD.

A chameleon collection by a well-known name in the designer world.

The Bagatelle collection was born out of the collaboration between designer Olivier Gagnère and THG Paris. A vegetal look in metal or the spirit of a dandy in black stone, this chameleon collection adapts to any interior.

Available in metal or semi-precious stone for basins, showers and baths, with a line of coordinated accessories, this series is available in a wide choice of finishes, including chrome, gold, soft gold, nickel, PVD finishes and rose gold.



Ref. U3F.151

Mélangeur de lavabo 3 trous
Rim mounted 3-hole basin mixer

COLLECTION

**BAGATELLE
PIERRE NOIRE**



Ref. U3E.151

Mélangeur de lavabo 3 trous
Rim mounted 3-hole basin mixer



Ref. U3F.40G

Mélangeur de lavabo 3 trous mural
Wall mounted basin set



Ref. U3E.112BSG

Mélangeur bain-douche 4 trous
Rim mounted 4-hole bath-shower mixer



Ref. U3E.504N

Anneau porte-serviette
Single towel ring



Ref. U3E.521/60

Porte-serviette
Single towel rail



Ref. U3E.500BD

Porte-savon mural
en porcelaine
Wall mounted porcelain
soap dish



Ref. U3E.536BD

Porte-verre
Tumbler

COLLECTION

**BAGATELLE
MÉTAL**



Ref. U3B.151

Mélangeur de lavabo 3 trous
Métal
Rim mounted 3-hole basin mixer
Metal



Ref. U3A.151

Mélangeur de lavabo 3 trous
Métal
Rim mounted 3-hole basin mixer
Metal



COLLECTION

CHEVERNY

Une collection extravagante et ornementée à l'image des bijoux royaux.

Plus colorée qu'Amboise, la collection Cheverny se distingue par son twist d'extravagance. Ses pierres semi-précieuses, jaspe rouge, malachite, onyx noir et lapis lazuli rappellent les ornements royaux.

Déclinée pour le lavabo, la douche et la baignoire avec une ligne d'accessoires coordonnés, cette série est disponible dans un large choix de finitions, parmi lesquelles le chrome, l'or, l'or pâle, le nickel, et de nombreuses finitions PVD.

An extravagant and ornamented collection modelled on the royal jewels.

More colorful than Amboise, the Cheverny collection is distinguished by its twist of extravagance. The semi-precious stones, red jasper, malachite, black onyx and blue lapis lazuli recall Royal ornaments..

Available for basins, showers and baths, with a line of coordinated accessories, this series is available in a wide choice of finishes, including chrome, gold, soft gold, nickel, PVD finishes.

COLLECTION

CHEVERNY LAPIS LAZULI



Ref. A1T.151

Mélangeur de lavabo 3 trous
lapis lazuli
Rim mounted 3-hole basin mixer
lapis lazuli



Ref. A1T.3202

Mélangeur de bidet
lapis lazuli
One-hole bidet mixer
lapis lazuli

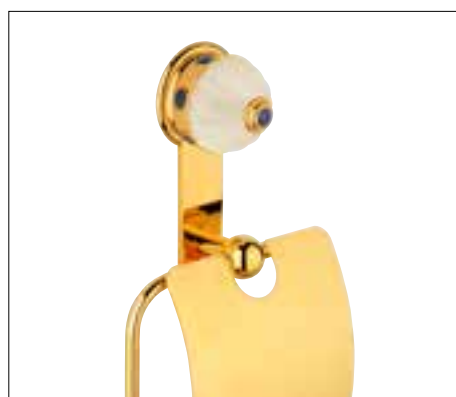

Ref. A1T.538AC

Porte-papier rouleau
lapis lazuli
Wall mounted WC paper holder
lapis lazuli

COLLECTION

CHEVERNY
**Ref. A1U.151**

Mélangeur de lavabo 3 trous
jaspe rouge
Rim mounted 3-hole basin mixer
red jasper

**Ref. U1V.151**

Mélangeur de lavabo 3 trous
onyx noir
Rim mounted 3-hole basin mixer
black onyx

**Ref. A1S.151**

Mélangeur de lavabo 3 trous
malachite
Rim mounted 3-hole basin mixer
malachite



COLLECTION

CYGNE

Une signature majestueuse et unique. Singulier et baroque, le cygne est la signature de cette collection. En pièce unique ou déclinée, le bec Cygne devient un objet de décoration. Déclinée pour le lavabo, la douche et la baignoire avec une ligne d'accessoires coordonnés, cette série est disponible dans un large choix de finitions, parmi lesquelles le chrome, l'or, l'or pâle, le nickel, et de nombreuses finitions PVD.

A majestic and unique signature. Singular and baroque, the swan is the signature of this collection. As a single piece or a set, the Swan's beak becomes an object of decoration. Available for basins, showers and baths, with a line of coordinated accessories, this series is available in a wide choice of finishes, including chrome, gold, soft gold, nickel, PVD finishes.



Ref. G31.29SGI

Bec de bain sur gorge à inversion
Rim mounted bath spout with diverter

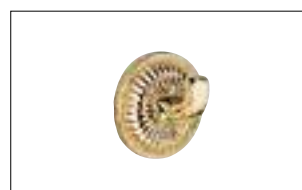

Ref. G31.508

Porte-peignoir
Robe hook



Ref. G31.517

Porte-peignoir
Robe hook



Ref. G31.504N

Anneau porte-serviette
Single towel ring



Ref. G31.538AC

Porte-papier rouleau
Bagues annelées
WC paper holder
Grooved rings



COLLECTION

DIPLOMATE

Design et symboles du luxe à la française. Bagues lisses ou travaillées, Diplomate est à la fois classique et contemporain, s'adaptant à tous les styles. Sobre et élégante, la collection Diplomate emprunte les codes du luxe à la française.

Déclinée pour le lavabo, la douche et la baignoire avec une ligne d'accessoires coordonnés, cette série est disponible dans un large choix de finitions, parmi lesquelles le chrome, l'or, l'or pâle, le nickel, et de nombreuses finitions PVD.

Modern design and symbols of French luxury. Smooth or intricate rings, Diplomate is both classic and contemporary, adapting to all styles. Sober and elegant, the Diplomate collection borrows French luxury codes.

Available for basins, showers and baths, with a line of coordinated accessories, this series is available in a wide choice of finishes, including chrome, gold, soft gold, nickel, PVD finishes.

COLLECTION

DIPLOMATE



Ref. U4B.3202

Mélangeur de bidet
Bagues annelées
One-hole bidet mixer
Grooved rings



Ref. U4B.538AC

Porte-papier rouleau
Bagues annelées
WC paper holder
Grooved rings



Ref. U4A.5540BE

Garniture pour mitigeur thermostatique
avec inverseur 2 sorties
et une sortie basse
Bagues lisses
Trim for thermostat 3 outlets (2-
way diverter with stop position
and 1 stop valve)
Smooth rings



Ref. U4C.5100B

Garniture pour mitigeur thermostatique
Bagues torsadées
Trim for thermostat
Roped rings



Ref. U4B.5500BE

Garniture pour mitigeur thermostatique
avec inverseur 2 sorties
Bagues annelées
Trim for thermostat
with 2-way diverter
Grooved rings



Ref. U4A.151

Mélangeur de lavabo 3 trous
Bagues lisses
Rim mounted 3-hole basin mixer
Smooth rings

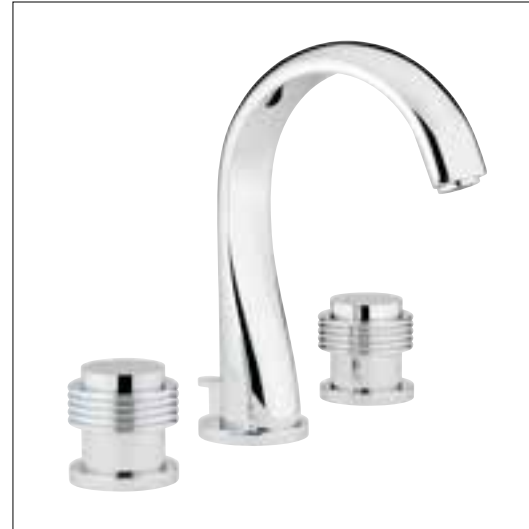

Ref. U4B.151

Mélangeur de lavabo 3 trous
Bagues annelées
Rim mounted 3-hole
basin mixer
Grooved rings



Ref. U4C.151

Mélangeur de lavabo 3 trous
Bagues torsadées
Rim mounted 3-hole basin mixer
Roped rings

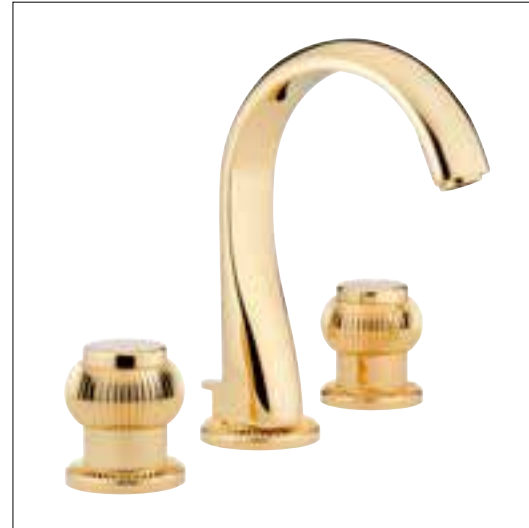

Ref. U4D.151

Mélangeur de lavabo 3 trous
Diplomate Royale
Rim mounted 3-hole basin mixer
Diplomate Royale



COLLECTION

DUOMO

S'inspirant de l'architecture italienne, les artisans THG Paris prouvent une nouvelle fois leur expertise à travers cette collection audacieuse. Hommage à la célèbre cathédrale « Duomo » de Milan, la collection emprunte l'élégance et les courbes de l'architecture italienne.

Entièrement travaillés à la main, les croisillons de la collection Duomo témoignent du savoir-faire unique de la Maison THG Paris. Insertion de cristal et triple finition sur une même pièce, Duomo anoblit la salle de bains.

Déclinée pour le lavabo, la douche et la baignoire avec une ligne d'accessoires coordonnés, cette série est disponible dans un large choix de finitions, parmi lesquelles le chrome, l'or, l'or pâle, le nickel, et de nombreuses finitions PVD.

Inspired by Italian architecture, the THG Paris' craftsmen have proved their expertise through this bold collection.

Named in honor of the renowned Duomo in Milan, revered for its classically inspired domed shape like many of the world's cathedrals, THG Paris' Duomo brings artistry and elegance to the bath. Only the most experienced hands can craft the incredible intricate designs inscribed in the domed handles. An expert in the art of bas-relief works on the plated surface to expose meticulously the coloured parts beneath each layer.

Available for basins, showers and baths, with a line of coordinated accessories, this series is available in a wide choice of finishes, including chrome, gold, soft gold, nickel, PVD finishes.

COLLECTION

DUOMO



Ref. U4E.151

Mélangeur de lavabo 3 trous
Rim mounted 3-hole basin mixer

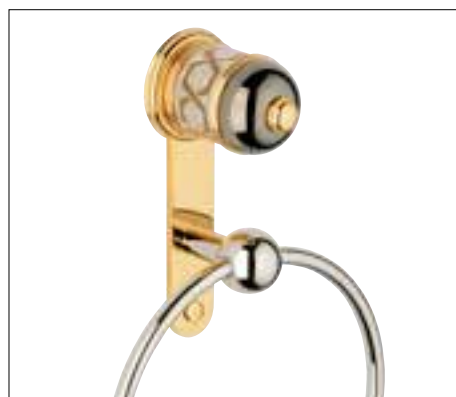

Ref. U4E.504N

Anneau porte-serviette
Single towel ring

COLLECTION

DUOMO
CRISTAL



Ref. U4F.151

Mélangeur de lavabo 3 trous
Cristal
Rim mounted 3-hole basin mixer
Crystal



Ref. U4F.52

Ensemble douchette mural
Wall mounted
handshower set



Ref. U4F.538AC

Porte-papier rouleau
Wall mounted WC paper holder



Ref. U4F.5500BE

Garniture pour mitigeur thermostatique
avec inverseur 2 sorties
Trim for thermostat
with 2-way diverter



Ref. U4F.5540BE

Garniture pour mitigeur thermostatique
avec inverseur 2 sorties et une sortie basse
Trim for thermostat 3 outlets
(2-way diverter with stop position
and 1 stop valve)



COLLECTION

JAIPUR

La collection Jaipur associe à merveille le travail d'une texture nervurée et de pierres semi-précieuses.

Déclinée en métal, onyx noir et cristal satiné, pour le lavabo, la douche et la baignoire avec une ligne d'accessoires coordonnés, cette série est disponible dans un large choix de finitions, parmi lesquelles le chrome, l'or, l'or pâle, le nickel, et de nombreuses finitions PVD.

The Jaipur collection pairs metal with black onyx or crystal to produce a delicate and beautiful pas de deux. The collection features a refined slender spout and charming handles with a delicate ribbed texture.

Available for basins, showers and baths, with a line of coordinated accessories, this series is available in a wide choice of finishes, including chrome, gold, soft gold, nickel, PVD finishes.



Ref. A9C.151

Mélangeur de lavabo 3 trous
onyx noir
Rim mounted 3-hole basin mixer
black onyx

COLLECTION

JAIPUR ONYX NOIR



Ref. A9C.40G

Mélangeur de lavabo 3 trous
mural
Wall mounted basin set



Ref. A9C.538AC

Porte-papier rouleau
Wall mounted WC paper
holder



Ref. A9C.5100B

Garniture pour mitigeur
thermostatique
Trim for thermostat



Ref. A9C.5540BE

Garniture pour mitigeur
thermostatique 5540AE
avec inverseur 2 sorties
et une sortie basse
Trim for thermostat 5540AE
3 outlets (2-way diverter with
stop position
and 1 stop valve)

COLLECTION

JAIPUR

CRISTAL SATINÉ ET MÉTAL



Ref. A9B.151

Mélangeur de lavabo 3 trous
Cristal satiné
Rim mounted 3-hole
basin mixer
Satinny crystal



Ref. A9B.40G

Mélangeur de lavabo
3 trous mural
Cristal satiné
Wall mounted basin set
Satinny crystal



Ref. A9B.5400BE

Garniture pour mitigeur
thermostatique avec 2 robinets
d'arrêt. Cristal satiné
Trim for thermostat
with 2 valves. Satiny crystal



Ref. A9B.504N

Anneau porte-serviette
Cristal satiné
Single towel ring
Satinny crystal



Ref. A9F.151

Mélangeur de lavabo 3 trous
Métal
Rim mounted 3-hole
basin mixer
Metal



Ref. A9F.5500BE

Garniture pour mitigeur
thermostatique
avec inverseur 2 sorties
Métal
Trim for thermostat with 2-way
diverter
Metal

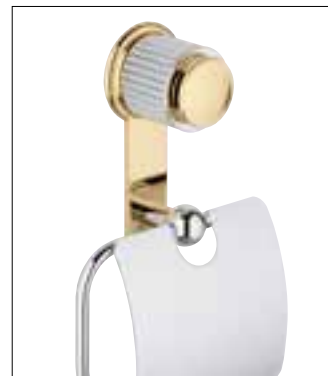

Ref. A9F.538AC

Porte-papier rouleau
Métal
WC paper holder
Metal



Ref. A9F.504N

Anneau porte-serviette
Métal
Single towel ring
Metal



COLLECTION

MANDARINE

Un fruit iconique, héritage du célèbre designer, Jean-Claude Delépine.

Fruit de la collaboration entre Jean-Claude Delépine et THG Paris, la collection Mandarine est devenue l'icône de THG Paris et l'emblème du chic à la française. Paradoxe entre sa forme simpliste et son style versatile, cette collection peut aussi bien s'adapter à une esthétique métallique et rétro, qu'à une ambiance prestige et baroque lorsque le croisillon se pare de cristal sculpté.

La collection Mandarine existe en version classique en métal mais également plus précieuse avec du cristal et du cristal sculpté en diamant.

Déclinée pour le lavabo, la douche et la baignoire avec une ligne d'accessoires coordonnés, cette série est disponible dans un large choix de finitions, parmi lesquelles le chrome, l'or, l'or pâle, le nickel, et de nombreuses finitions PVD.

An iconic fruit and legacy of famous designer, Jean-Claude Delépine.

Fruit of the collaboration between Jean-Claude Delépine and THG Paris, the Mandarine collection has become the icon of THG Paris and the emblem of French chic. With the paradox between its simplistic form and its versatile style, this collection can adapt equally to retro metal aesthetics, as well as to a prestigious and Baroque atmosphere when the brace is adorned with sculpted crystal.

The Mandarine collection is available in a classic metal version as well as in a more precious version with crystal and diamond cut crystal.

Available for basins, showers and baths, with a line of coordinated accessories, this series is available in a wide choice of finishes, including chrome, gold, soft gold, nickel, PVD finishes.

COLLECTION

MANDARINE
MÉTAL



Ref. U1A.151

Mélangeur de lavabo 3 trous
Rim mounted 3-hole basin mixer



Ref. U1A.2155

Mélangeur de lavabo
One-hole basin mixer



Ref. U1A.5500BE

Garniture pour mitigeur thermostatique
avec inverseur 2 sorties
Trim for thermostat with 2-way diverter



Ref. U1A.546GM

Coupe porte-savon
Soap dish



Ref. U1A.504N

Anneau porte-serviette
Single towel ring

COLLECTION

MANDARINE CRISTAL



Ref. U1D.151

Mélangeur de lavabo
3 trous mural
Wall mounted basin set



Ref. U1D.40G

Mélangeur de lavabo
3 trous mural
Wall mounted basin set



Ref. U1D.5100B

Garniture pour mitigeur
thermostatique
Trim for thermostat



Ref. U1D.5540BE

Garniture pour mitigeur
thermostatique avec
inverseur
2 sorties et une sortie basse
Trim for thermostat 5540AE
3 outlets (2-way diverter
with stop position)



Ref. U1D.52

Ensemble douchette mural
Wall mounted
handshower set



Ref. U1D.546GM

Coupe porte-savon
Soap dish



Ref. U1D.508

Porte-peignoir
Robe hook



Ref. U1D.504N

Anneau porte-serviette
Single towel ring

COLLECTION

MANDARINE
CRISTAL SATINÉ



Ref. U1E.151

Mélangeur de lavabo 3 trous
Rim mounted 3-hole basin mixer

COLLECTION

MANDARINE
CRISTALLIA DIAMANT



Ref. U1K.151

Mélangeur de lavabo 3 trous
Rim mounted 3-hole basin mixer



Ref. U1K.2155

Mélangeur de lavabo
One-hole basin mixer

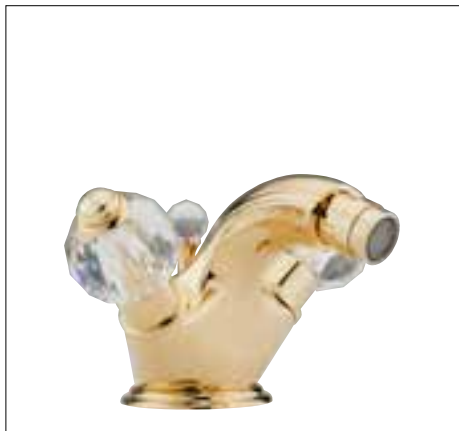

Ref. U1K.3202

Mélangeur de bidet
One-hole bidet mixer



Ref. U1K.546GM

Coupe porte-savon
Soap dish



COLLECTION

NAJEM

Esthétique orientale et invitation au voyage. Comme une invitation au voyage, la collection Najem emprunte tous les codes du luxe oriental. Finitions travaillées et cristaux taillés, les éléments de la série Najem nous transportent dans les contes des Mille et une Nuits. Déclinée pour le lavabo, la douche et la baignoire avec une ligne d'accessoires coordonnés, cette série est disponible dans un large choix de finitions, parmi lesquelles le chrome, l'or, l'or pâle, le nickel, et de nombreuses finitions PVD.

Oriental aesthetics and a voyage of discovery. Like a voyage of discovery, the Najem collection uses all the codes of oriental luxury. Sophisticated finishes and cut crystals, the elements of the Najem series transport you to the tales of the Arabian Nights. Available for basins, showers and baths, with a line of coordinated accessories, this series is available in a wide choice of finishes, including chrome, gold, soft gold, nickel, PVD finishes.



Ref. E53.151

Mélangeur de lavabo 3 trous
Rim mounted 3-hole basin mixer



Ref. E53.538AC

Porte-papier rouleau
Wall mounted WC paper holder



Ref. E53.504N

Anneau porte-serviette
Single towel ring



COLLECTION

SULLY

Suivant les collections Amboise et Cheverny, la série Sully est l'aboutissement et l'apogée du style classique-baroque accentué par l'accumulation de pierres semi-précieuses telles que le lapis lazuli, malachite, onyx noir et jaspé rouge.

Déclinée pour le lavabo, la douche et la baignoire avec une ligne d'accessoires coordonnés, cette série est disponible dans un large choix de finitions, parmi lesquelles le chrome, l'or, l'or pâle, le nickel, et de nombreuses finitions PVD.

Classic shapes and fine materials for a very French luxury collection.

Striking and ornate, the jewel-encrusted Sully is part of the Prestige collection and was created for THG Paris by Jean-Claude Delépine, designer of some of the world's most coveted interiors. Regarded for outfitting five star hotels, royal palaces and opulent residences around the globe, THG Paris' Sully epitomizes luxury with its intricate detailing and jewel like construction. Available for basins, showers and baths, with a line of coordinated accessories, this series is available in a wide choice of finishes, including chrome, gold, soft gold, nickel, PVD finishes.

COLLECTION

SULLY

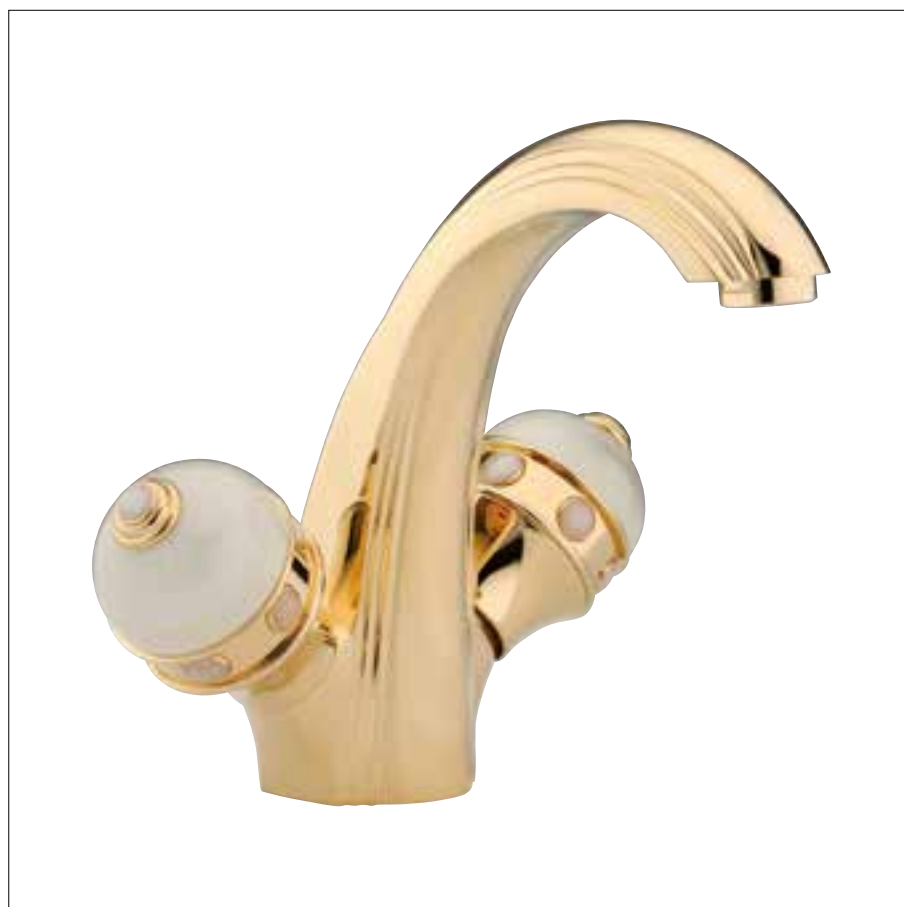

Ref. U1S.2155

Mélangeur de lavabo monotrou
onyx blanc
Rim mounted 1-hole basin mixer
white onyx



Ref. U1S.151

Mélangeur de lavabo 3 trous
onyx blanc
Rim mounted 3-hole basin mixer
white onyx



Ref. A1W.151

Mélangeur de lavabo 3 trous
lapis lazuli
Rim mounted 3-hole basin mixer
lapis lazuli



Ref. A1X.151

Mélangeur de lavabo 3 trous
jaspe rouge
Rim mounted 3-hole basin mixer
red jasper



Ref. U1T.151

Mélangeur de lavabo 3 trous
onyx noir
Rim mounted 3-hole basin mixer
black onyx



Ref. A1V.151

Mélangeur de lavabo 3 trous
malachite
Rim mounted 3-hole basin mixer
malachite



COLLECTION

TÊTE DE LION

Référence artistique, lignes redessinées.
Ornementation classique par excellence, la collection Tête de Lion fait référence à l'art et à la puissance de l'Empire romain. Réinventée et redessinée par THG Paris, cette pièce unique s'intègre dans tous les styles, avec audace et désinvolture.

An artistic reference, redesigned lines.
Classic ornamentation par excellence, the Tête de lion collection refers to the art and power of the Roman Empire. Reinvented and redesigned by THG Paris, this unique piece adapts to all styles with both audacity and casualness.



Ref. G99.22TLA

Tête de Lion assyrien
Wall mounted lion's head (large size)



Ref. G99.22GM

Tête de Lion romain
Wall mounted lion's head
(medium size)



Ref. G99.22F

Tête de Lion petit modèle
Wall mounted lion's head
(small size)



COLLECTION

TROCADÉRO

Lignes architecturales pour une collection joaillière et opulente.

Inspirée de l'architecture de la célèbre place parisienne qui abrite quelques-uns des sites les plus prisés de Paris, la collection Trocadéro est travaillée comme un bijou opulent et luxueux. Ornée de pierres semi-précieuses, c'est une collection étincelante et flamboyante.

Cette collection est disponible en jaspe rouge, malachite, onyx noir, lapis lazuli et œil de tigre. Déclinée pour le lavabo, la douche et la baignoire avec une ligne d'accessoires coordonnés, cette série est disponible dans un large choix de finitions, parmi lesquelles le chrome, l'or, l'or pâle, le nickel, et de nombreuses finitions PVD.

Opulent and luxury collection, inspired by the Parisian architecture.

Part of the Prestige collection, Trocadero is named after the famed Parisian street and Metro stop, which is home to some of the city's most regarded sights, among them, the Eiffel Tower. Encrusted with fine stones reminiscent of those usually reserved for royalty, Trocadero is a sparkling and flamboyant collection.

Available for basins, showers and baths, with a line of coordinated accessories, this series is available in a wide choice of finishes, including chrome, gold, soft gold, nickel, PVD finishes.

COLLECTION

TROCADÉRO ŒIL DE TIGRE



Ref. U7E.151

Mélangeur de lavabo 3 trous
œil de tigre
Rim mounted 3-hole basin mixer
Tiger eye



Ref. U7E.40G

Mélangeur de lavabo 3 trous mural
Wall mounted basin set



Ref. U7E.5540BE

Garniture pour mitigeur thermostatique
avec inverseur 2 sorties et une sortie basse
Trim for thermostat 3 outlets
(2-way diverter with stop position
and 1 stop valve)



Ref. U7E.5100B

Garniture pour mitigeur thermostatique
Trim for thermostat

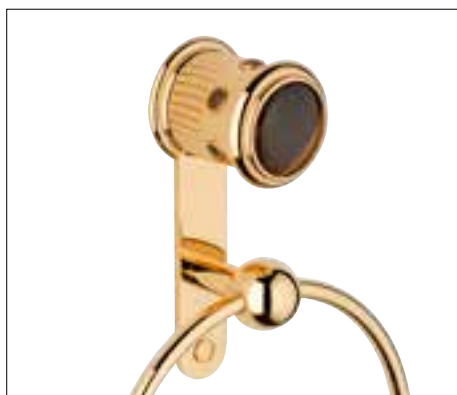

Ref. U7E.504N

Anneau porte-serviette
Single towel ring

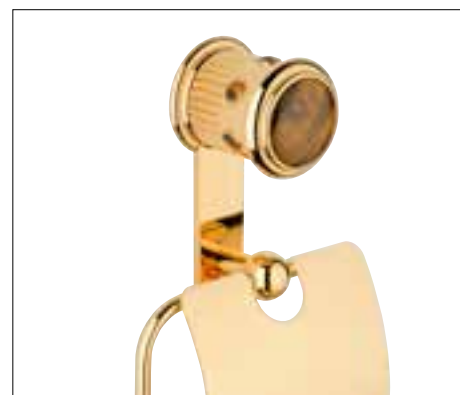

Ref. U7E.538AC

Porte-papier rouleau
Wall mounted WC paper holder

COLLECTION

TROCADÉRO

**Ref. U7B.151**

Mélangeur de lavabo 3 trous
lapis lazuli
Rim mounted 3-hole basin mixer
lapis lazuli

**Ref. U7C.151**

Mélangeur de lavabo 3 trous
jaspe rouge
Rim mounted 3-hole basin mixer
red jasper

**Ref. U7D.151**

Mélangeur de lavabo 3 trous
onyx noir
Rim mounted 3-hole basin mixer
black onyx

**Ref. U7A.151**

Mélangeur de lavabo 3 trous
malachite
Rim mounted 3-hole basin mixer
malachite



COLLECTION

VERSAILLES

Représentation d'une élégance passée.

En l'honneur du célèbre et opulent château français construit par le roi Louis XIV, cette collection reprend un design classique mais riche en décors et matériaux nobles.

À la manière d'une gravure, les croisillons s'ornent d'apparets floraux et précieux pour offrir un style typiquement français recherché dans le monde entier.

Déclinée pour le lavabo, la douche et la baignoire avec une ligne d'accessoires coordonnés, cette série est disponible dans un large choix de finitions, parmi lesquelles le chrome, l'or, l'or pâle, le nickel, et de nombreuses finitions PVD.

A representation of past elegance.

In honour of this famous and opulent French château built by King Louis XIV, this collection takes on a classic design but rich in decorations and noble materials.

In the manner of an engraving, the braces are decorated with floral and precious pomp to offer a typically French style sought after all over the world.

Available for basins, showers and baths, with a line of coordinated accessories, this series is available in a wide choice of finishes, including chrome, gold, soft gold, nickel, PVD finishes.



Ref. G14.151

Mélangeur de lavabo 3 trous
Rim mounted 3-hole basin mixer



Ref. G14.40G

Mélangeur de lavabo 3 trous mural
Wall mounted basin set



Ref. G14.112BG

Mélangeur bain-douche 4 trous
Rim mounted 4-hole bath-shower mixer



COLLECTION

VOGUE

La parfaite alliance du cristal et de pierres fines. Sphère de cristal clair taillé, surplombée d'une pierre semi-précieuse, la collection Vogue se distingue des collections Amboise et Cheverny, dans l'abstraction et la sobriété. Moins d'ornements, mais des déclinaisons de couleurs, Vogue est une collection intemporelle ; une pièce d'art sophistiquée.

Déclinée pour le lavabo, la douche et la baignoire avec une ligne d'accessoires coordonnés, cette série est disponible dans un large choix de finitions, parmi lesquelles le chrome, l'or, l'or pâle, le nickel, et de nombreuses finitions PVD.

A flawless combination of crystal and fine stones. THG Paris perfects the delicate combination of crystal and semi precious stones with the Vogue collection. Elaborate yet graceful, this luxury bath series features a multitude of gemstone colors, including: amethyst, blue lapis lazuli, red jasper, malachite, brown tiger eye and black onyx. Each stone is inlaid atop a smooth crystal handle and framed by solid brass in any number of finishes. This unique mixture of materials allow the Vogue collection to stand out as a truly astounding example of sophisticated artistry. Available for basins, showers and baths, with a line of coordinated accessories, this series is available in a wide choice of finishes, including chrome, gold, soft gold, nickel, PVD finishes.

COLLECTION

VOGUE
AMÉTHYSTE



Ref. A8B.151

Mélangeur de lavabo 3 trous
Rim mounted 3-hole basin mixer



Ref. A8B.40G

Mélangeur de lavabo 3 trous mural
Wall mounted basin set



Ref. A8B.517

Porte-peignoir
Robe hook



Ref. A8B.504N

Anneau porte-serviette
Single towel ring



Ref. A8B.538AC

Porte-papier rouleau
Wall mounted WC paper holder

COLLECTION

VOGUE



Ref. A8S.151

Mélangeur de lavabo 3 trous
lapis lazuli
Rim mounted 3-hole basin mixer
lapis lazuli



Ref. A8N.151

Mélangeur de lavabo 3 trous
jaspe rouge
Rim mounted 3-hole basin mixer
red jasper



Ref. A8R.151

Mélangeur de lavabo 3 trous
œil de tigre
Rim mounted 3-hole basin mixer
tiger eye



Ref. A8P.151

Mélangeur de lavabo 3 trous
onyx noir
Rim mounted 3-hole basin mixer
black onyx



Ref. A8M.151

Mélangeur de lavabo 3 trous
malachite
Rim mounted 3-hole basin mixer
malachite

COLLECTION

LES BASIQUES



Ref. GB2.2/BP

Vasque métal ovale 49 x 36 cm
Oval metal basin 19 ½" x 14 ½"



Ref. GB2.4/BP

Vasque métal rectangulaire 49 x 33 cm
Rectangular metal basin 19 5/16" x 13"

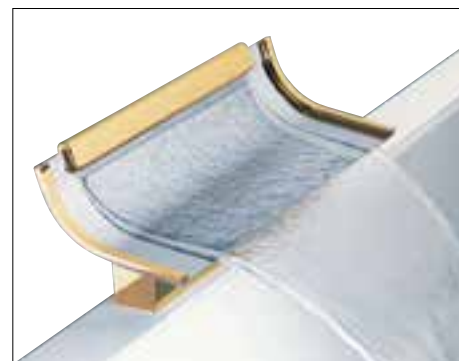

Ref. A44.29NIA/D

ELLIPSE - Bec de bain 400 mm
ELLIPSE - Waterfall bath spout 400 mm
(16")



Ref. G00.704

Boîte à mouchoirs à poser
Tissue box



Ref. G00.290/B

Jet de massage avec système Easyclean
Body jet with Easyclean system



Ref. G00.661

Miroir mural double face
Wall mounted mirror 2 faces

COLLECTION

LES BASIQUES



Ref. G00.910PR

Pomme de douche Ø 260 mm avec système Easyclean et bras 1"
Showerhead Ø 260 mm (10 ¼") with Easyclean system and 1" showerarm

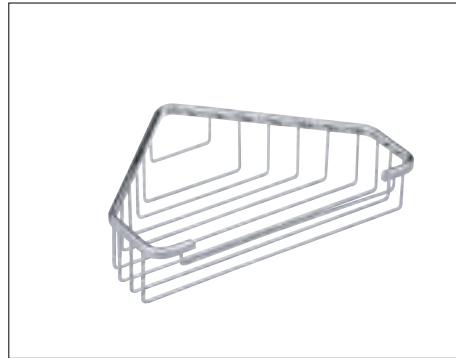

Ref. G00.3626

Porte-savon fil mural d'angle 200 x 200 mm
Large net corner soap dish 200x200 mm (8"x 8")



Ref. G00.3640

Douche lame d'eau 3/4"
Waterfall showerhead ¾"



Ref. G00.286P + Ref. 84L

Pomme de douche Ø 200 mm à picots avec système Easyclean et bras mural
Shower head Ø 200 mm (8") with Easyclean system and showerarm



Ref. G00.280EP + Ref. 84L

Pomme Ø 300 mm avec système Easyclean et bras mural
Showerhead Ø 300 mm (12") with Easyclean system and showerarm



Ref. G00.288L + Ref. 82

Pomme de douche Ø 70 mm grille laiton avec système Easyclean, à débit variable
Adjustable showerhead with Easyclean system Ø 70 mm (2 ¾")

LES FINITIONS

FINISHES

Avec son savoir-faire unique, THG Paris vous présente depuis 60 ans des collections de robinetteries et d'accessoires de salle de bains d'exception.

Afin de rester en adéquation avec les aspirations modernes la palette des finitions a été actualisée.

Chrome, nickel, or, argent rhodié ou bronze sont toujours proposés mais une gamme or rose, or pâle et de nouveaux traitements PVD sont maintenant disponibles.

La finition luxbrass est quant à elle remplacée par le PVD couleur laiton ou l'or pâle.

Avantages du PVD :

- Excellente résistance à la corrosion et à l'abrasion.
- Dureté du traitement très importante (2000 Vickers)
- Excellente tenue de la couleur dans le temps.

With its unique know-how THG Paris has been presenting for the past 60 years exceptional brassware and accessories collections.

In order to keep up with the new modern trends, the finishes have been upgraded.

Chrome, nickel, gold, silver rhodium or bronze are still in the catalogue but rose gold, soft gold and PVD coating are now available.

The luxbrass finish is now replaced by PVD brass or soft gold.

PVD advantages:

- Excellent resistance to corrosion and abrasion
- High performance hardness (2000 Vickers)
- Excellent durability and long-lasting color.



A02
CHROME
POLISHED CHROME



B01
NICKEL
POLISHED NICKEL



C01
NICKEL MAT
MATT NICKEL



D24
ARANJA
BLACK NICKEL (ARANJA)



F30
OR PÂLE
SOFT GOLD



F31
OR PÂLE MAT
SOFT MATT GOLD



F32
OR PÂLE SATINÉ
SOFT SATIN GOLD



F27
OR ROSE
ROSE GOLD



F01
DORÉ
POLISHED GOLD



F07
DORÉ MAT
MATT GOLD



D01
BRONZE CLAIR VERNIS BRILLANT
LACQUERED LIGHT BRONZE



D05
BRONZE CLAIR VERNIS MAT
LACQUERED MATT BRONZE



H03
VIEIL ARGENT VERNIS BRILLANT
LACQUERED ANTIQUE SILVER



H28
VIEUX NICKEL
ANTIQUÉ NICKEL



H55
PVD NICKEL
NICKEL COLOR PVD



H56
PVD NICKEL MAT
MATT NICKEL COLOR PVD



H49
PVD LAITON
BRASS COLOR PVD



H50
PVD LAITON MAT
MATT BRASS COLOR PVD



H52
PVD DORÉ
GOLD COLOR PVD



H53
PVD DORÉ MAT
MATT GOLD COLOR PVD



F33
PVD BRONZE BROWN
BROWN BRONZE COLOR PVD



F34
PVD BRONZE BROWN MAT
MATT BROWN BRONZE
COLOR PVD



H62
PVD BLUSH
BLUSH PVD



H60
PVD BLUSH MAT
MATT BLUSH PVD

LES FILIALES ET REVENDEURS SUBSIDIARIES AND DISTRIBUTORS

SIÈGE SOCIAL

HEAD OFFICE

THG FRANCE

35, rue Tournière - BP 80212
Béthencourt-sur-Mer
80535 Friville cedex -
France
+33 (0)3 22 60 20 80
contact@thg.fr
www.thg-paris.com

FILIALES

SUBSIDIARIES

THG USA LLC

Head office
441 NW - 1st avenue
Fort Lauderdale
FL 33301 - USA
Tel. +1 954 425 8225
info@thgusa.com

THG DEUTSCHLAND GMBH

Gutleutstr. 96
60329 Frankfurt/Main
Deutschland
Tel. +49 (0)69/ 25 78 14 33
info@thg-deutschland.de

THG UK

11 Commercial Way,
Abbey Road,
London,
NW10 7XF
United Kingdom
Tel. +44 (0)20 8202 8288
salesuk@thg-paris.com

THG RUSSIA

Leningradskiy avenue,
bld. 37A, housing 14
125167 Moscow
Russia
Tel. +7 495 800 8225
akormova@thg-paris.com

THG ASIA

Room 1901, Rui Jin Building
205 South Maoming Road
Shanghai - PRC
上海市卢湾区茂名南路205号瑞金大厦1901室
电话/ Tel. +86 (21) 613 527 38
contact@thg-asia.cn

THG MIDDLE EAST

Alan Haddad
Dubai Design District
Building 3, Office 605
Dubai, UAE
Tel. +971 508 456 003
ahaddad@thg.fr

SHOWROOMS THG PARIS

THG PARIS SHOWROOMS

PARIS

JCD Delépine
152 bd Haussmann
75008 Paris - France
Tel. +33 (0)1 44 20 09 20
info@delepine.com
www.delepine.com

LONDON

4 Pont Street
London SW1X 9EL
United Kingdom
Tel. +44 (0)20 7838 7788
salesuk@thg-paris.com
london.thg-paris.com

NEW YORK

D&D Building
Showroom 1206 - 12th floor
979 Third Avenue - New-York
NY 10022 - USA
Tel. +1 (917) 242 8911
info@thgusa.com

Retrouvez l'ensemble
de nos revendeurs sur :
Find all our resellers on:
www.thg-paris.com



Nos gammes de sanitaires et sèche-serviettes sont à retrouver sur :

Our sanitaryware and towel warmers ranges can be found on:

www.thg-paris.com

CRÉDITS / CREDITS

CONCEPTION / RÉALISATION / PHOTOS : THG Paris

IMPRESSION : Imprimerie Jean Bernard

Textes et photos non contractuels
et susceptibles d'être modifiés sans préavis

Text and pictures are not binding
and can be modified without any previous notice

© THG novembre 2019

FABRICANT FRANÇAIS



Entreprise
du Patrimoine
Vivant
L'excellence
des savoir-faire
français

