

**THERE'S  
SOMETHING  
NEW.**

NEWS 2021 – LISTINO PREZZI / PRICE LIST

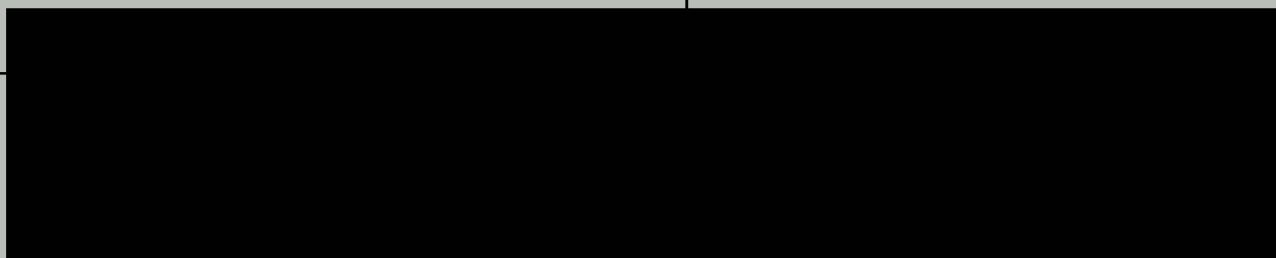
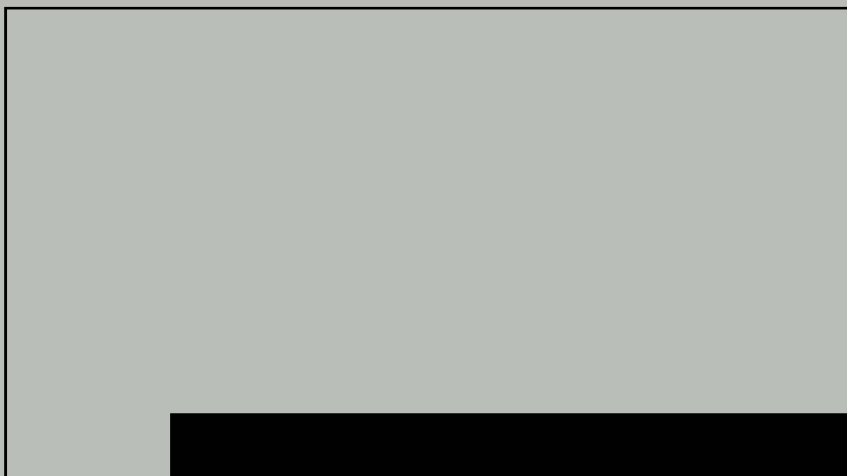

**falper.**

Listino prezzi in punti

1 Punto = 1,10 € IVA esclusa

Price list in points

1 Point = 1,10 € excluding VAT

Preisliste in Punkten

1 Punkt = 1,10 € ohne Mehrwertsteuer

List de prix en points







1 point = 1,10 € hors TVA

Tarifa de precios en puntos

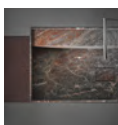
1 punto = 1,10 € IVA excluido

**falper.**

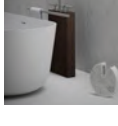
## INDICE / INDEX

|   |   |              |
|---|---|--------------|
|    | <b>MINIMUM</b>   <i>Minimum</i><br>Minimum   Minimum<br>Minimum   | Pag 04 – 26  |
|    | <b>BUTLER SISTEMA GUARDAROBA PER BAGNO</b>   <i>Butler bathroom wardrobe system</i><br>Butler Gardarobesystem für Badezimmer   Butler système garde-robe pour salle de bain<br>Butler Sistema vestuario para Baño | Pag 27 – 31  |
|    | <b>DIVISORI CASSETTI</b>   <i>Drawer dividers</i><br>Schubladeneinteiler   Séparateurs pour tiroirs<br>Separadores para cajones   | Pag 32 – 35  |
|    | <b>ACCESSORI CILINDRO</b>   <i>Cilindro accessories</i><br>Cilindro Zubehör   Accessoires Cilindro<br>Opcionales Cilindro   | Pag. 36 – 41 |
|    | <b>PORTA RUBINETTI</b>   <i>Tap holder</i><br>Armatureträger   Porte-Robinets<br>Suporte para grifería  | Pag. 42 – 44 |
|  | <b>LAVABI DA TERRA</b>   <i>Freestanding basins</i><br>Freistehende Waschbecken   Lavabos à colonne<br>Lavabos en columna   | Pag. 45 – 47 |
|  | <b>SPECCHIO CONTENITORE</b>   <i>Mirror cabinets with lighting</i><br>Spiegelschränke mit Beleuchtung   Armoires de toilette avec éclairage<br>Espejos contenedores con luz                                       | Pag. 48 – 50 |
|   | <b>CONDIZIONI DI VENDITA</b>   <i>Sale conditions</i>   | Pag. 51 – 53 |

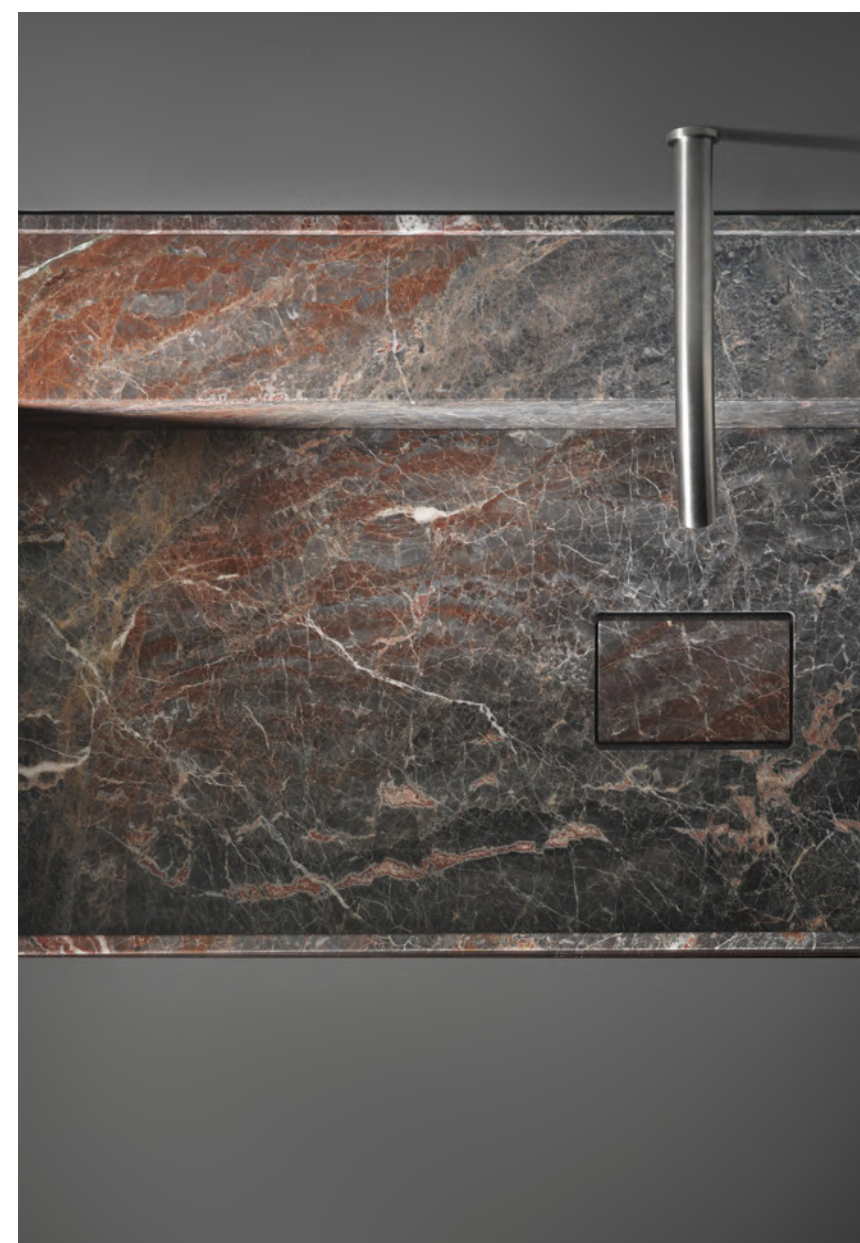

# MINIMUM LAVABI | *Minimum washbasins*

Minimum Waschbecken | Minimum lavabos | Minimum lavabos

**FINITURE** | Finishes | Oberfläche | Finitions | Acabados

## Marmi 1

**Marbles 1** | Marmor 1 | Marbre 1 | Marmol 1



**MC**  
**Carrara**  
Carrara  
Carrara  
Carrara  
Carrara

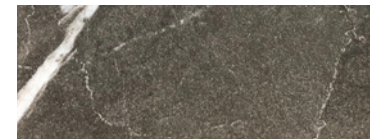

**MI**  
**Pietra Grey**  
Piedra gris  
Piedra gris  
Piedra gris  
Piedra gris

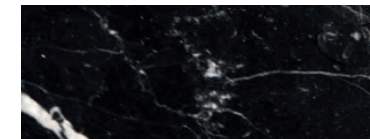

**MQ**  
**Nero Marquina**  
Nero Marquina  
Nero Marquina  
Nero Marquina  
Nero Marquina

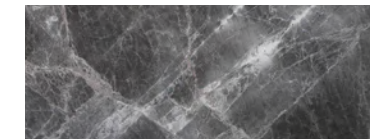

**U1**  
**Jolie Grey**  
Jolie Grey  
Jolie Grey  
Jolie Grey  
Jolie Grey

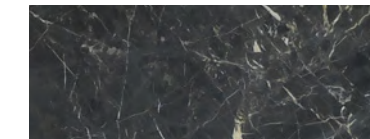

**U3**  
**Grey Saint Laurent**  
Grey Saint Laurent  
Grey Saint Laurent  
Grey Saint Laurent  
Grey Saint Laurent

## Marmi 2

**Marbles 2** | Marmor 2 | Marbre 2 | Marmol 2



**MR**  
**Statuario**  
Statuary  
Statuarisch  
Statuaire  
Estatuario



**MP**  
**Calacatta Gold**  
Calacatta Gold  
Calacatta Gold  
Calacatta Gold  
Calacatta Gold



**U2**  
**Noir Saint Laurent**  
Noir Saint Laurent  
Noir Saint Laurent  
Noir Saint Laurent  
Noir Saint Laurent



**U4**  
**Arabescato Corchia**  
Arabescato Corchia  
Arabescato Corchia  
Arabescato Corchia  
Arabescato Corchia



**U5**  
**Rosso Lepanto**  
Rosso Lepanto  
Rosso Lepanto  
Rosso Lepanto  
Rosso Lepanto

## Cemento

**Concrete** | Zement | Ciment | Cemento



**UA**  
**Grey 110/B**  
Grey 110/B  
Grey 110/B  
Grey 110/B  
Grey 110/B

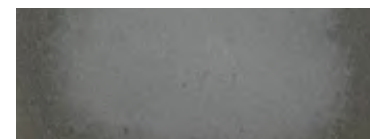

**UB**  
**Grey 150/B**  
Grey 150/B  
Grey 150/B  
Grey 150/B  
Grey 150/B



**UC**  
**Grey 180/B**  
Grey 180/B  
Grey 180/B  
Grey 180/B  
Grey 180/B

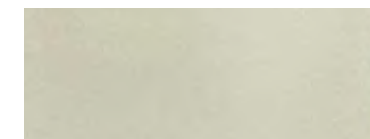

**UD**  
**Green 505/B**  
Green 505/B  
Green 505/B  
Green 505/B  
Green 505/B



**UE**  
**Green 540/B**  
Green 540/B  
Green 540/B  
Green 540/B  
Green 540/B



**UF**  
**Green 570/B**  
Green 570/B  
Green 570/B  
Green 570/B  
Green 570/B



**UG**  
**Blue 430/B**  
Blue 430/B  
Blue 430/B  
Blue 430/B  
Blue 430/B



**UH**  
**Blue 460/B**  
Blue 460/B  
Blue 460/B  
Blue 460/B  
Blue 460/B



**UJ**  
**Blue 480/B**  
Blue 480/B  
Blue 480/B  
Blue 480/B  
Blue 480/B



**UL**  
**Terra 730/B**  
Terra 730/B  
Terra 730/B  
Terra 730/B  
Terra 730/B



**UM**  
**Terra 770/B**  
Terra 770/B  
Terra 770/B  
Terra 770/B  
Terra 770/B

## Cristalplant Biobased

**Cristalplant Biobased** | Cristalplant Biobased | Cristalplant Biobased | Cristalplant Biobased

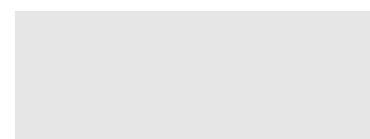

**00**  
**Bianco opaco**  
Matt white  
Weiss matt  
Blanc mat  
Blanco mate

# MINIMUM LAVABI | *Minimum washbasins*

Minimum Waschbecken | Minimum lavabos | Minimum lavabos

## LAVABO A PARETE | Wall-mounted washbasin | Wandwaschbecken | Lavabo au mur | Lavabo a pared

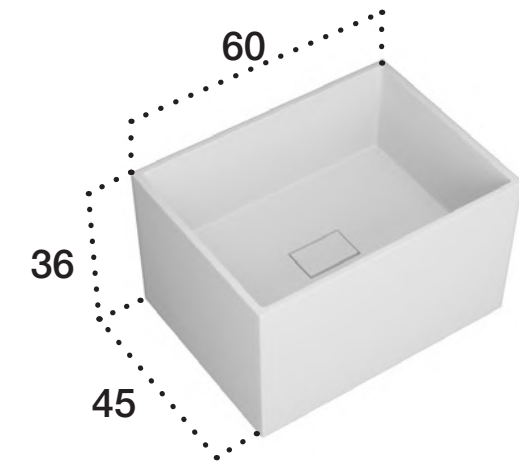

| Art.       | P  | L  | H  |
|------------|----|----|----|
| <b>N14</b> | 45 | 60 | 36 |
| <b>N12</b> | 45 | 60 | 36 |
| <b>N13</b> | 45 | 60 | 36 |

| Cemento      | Marmo 1      | Marmo 2      |
|--------------|--------------|--------------|
| Cement       | Marble 1     | Marble 2     |
| <b>3.110</b> | <b>4.240</b> | <b>5.260</b> |

### Accessori compresi / Included accessories

| Piletta / Waste | Copri piletta in finitura / Drain cover in finish | Troppo pieno / Overflow |
|-----------------|---|-------------------------|
| Art. 55F        | Cemento / Marmo 1 / Marmo 2                       | No                      |

### Accessori suggeriti / suggested accessories

| Sifone / Trap |
|---------------|
| 673           |

## LAVABO A PARETE | Wall-mounted washbasin | Wandwaschbecken | Lavabo au mur | Lavabo a pared

Versione SX | Left version

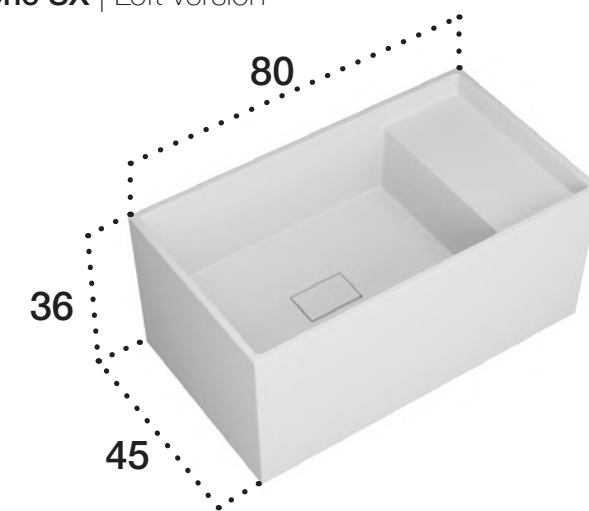

| Art.                   | P  | L  | H  |
|------------------------|----|----|----|
| <b>N27 DX • N28 SX</b> | 45 | 80 | 36 |
| <b>N25 DX • N26 SX</b> | 45 | 80 | 36 |
| <b>N23 DX • N24 SX</b> | 45 | 80 | 36 |

| Cemento      | Marmo 1      | Marmo 2      |
|--------------|--------------|--------------|
| Cement       | Marble 1     | Marble 2     |
| <b>4.550</b> | <b>4.920</b> | <b>6.120</b> |

### Accessori compresi / Included accessories

| Piletta / Waste | Copri piletta in finitura / Drain cover in finish | Troppo pieno / Overflow |
|-----------------|---|-------------------------|
| Art. 55F        | Cemento / Marmo 1 / Marmo 2                       | No                      |

### Accessori suggeriti / suggested accessories

| Sifone / Trap |
|---------------|
| 673           |

## LAVABO A PARETE | Wall-mounted washbasin | Wandwaschbecken | Lavabo au mur | Lavabo a pared

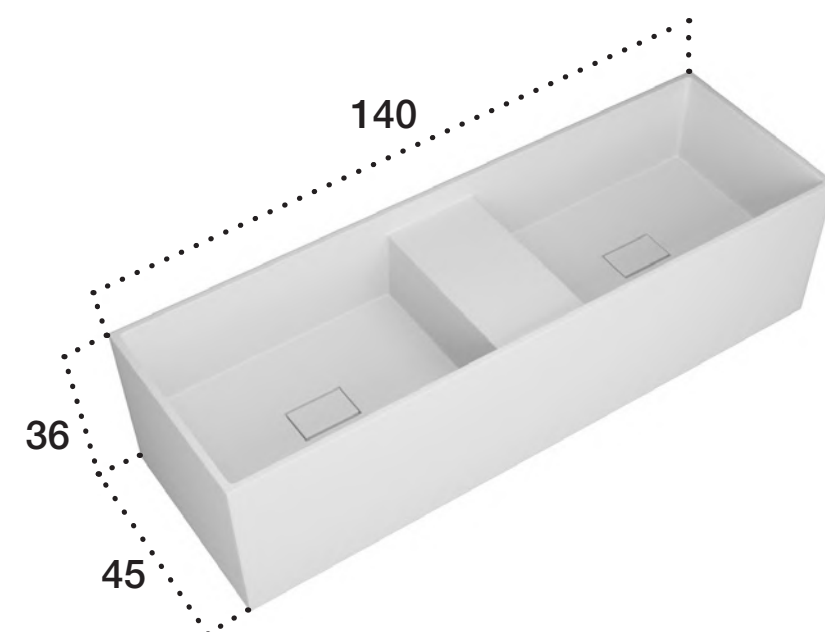

| Art.       | P  | L   | H  |
|------------|----|-----|----|
| <b>N33</b> | 45 | 140 | 36 |
| <b>N34</b> | 45 | 140 | 36 |

| Marmo 1      | Marmo 2      |
|--------------|--------------|
| Marble 1     | Marble 2     |
| <b>7.120</b> | <b>8.950</b> |

### Accessori compresi / Included accessories

| Piletta / Waste | Copri piletta in finitura / Drain cover in finish | Troppo pieno / Overflow |
|-----------------|---|-------------------------|
| Art. 55F        | Cemento / Marmo 1 / Marmo 2                       | No                      |

### Accessori suggeriti / suggested accessories

| Sifone / Trap |
|---------------|
| 673           |

Lavabi comprensivi di staffa in metallo per fissaggio a parete | The washbasin include the brackets for wall-mounting | Die Abstützbügel für Wandmontage sind in Lieferumfang der Becken inbegriffen | Lavabos avec supports en métal pour montage au mur inclus | Los soportes para el montaje a la pared están incluido en los lavabos

# MINIMUM LAVABI | *Minimum washbasins*

Minimum Waschbecken | Minimum lavabos | Minimum lavabos

## LAVABO DA APPOGGIO | Countertop washbasin | Aufsatzbecken | Vasque à poser | Lavabo de apoyo

Versione SX | Left version

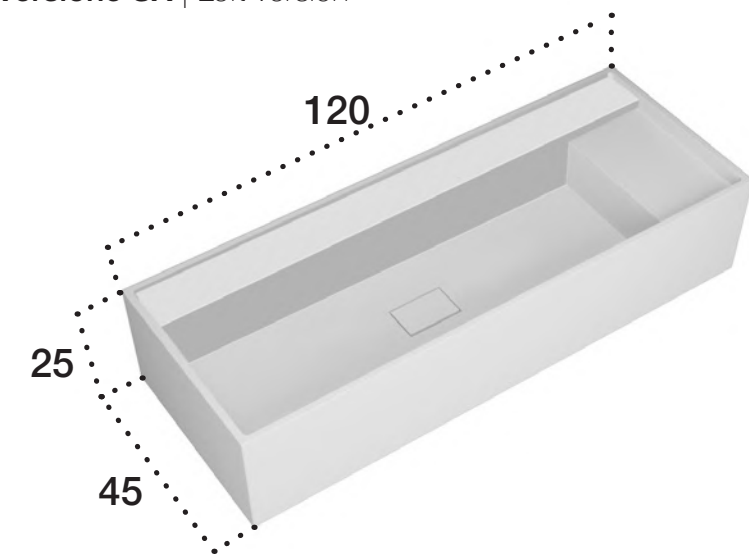

| Art.                   | P  | L   | H  |
|------------------------|----|-----|----|
| <b>N46 DX • N47 SX</b> | 45 | 120 | 25 |
| <b>N44 DX • N45 SX</b> | 45 | 120 | 25 |
| <b>N42 DX • N43 SX</b> | 45 | 120 | 25 |

| Cemento      | Marmo 1      | Marmo 2      |
|--------------|--------------|--------------|
| Cement       | Marble 1     | Marble 2     |
| <b>5.120</b> | <b>6.120</b> | <b>7.720</b> |

Accessori compresi / Included accessories

| Piletta / Waste | Copri piletta in finitura / Drain cover in finish | Troppo pieno / Overflow |
|-----------------|---|-------------------------|
| Art. 55F        | Cemento / Marmo 1 / Marmo 2                       | No                      |

Accessori suggeriti / suggested accessories

| Sifone / Trap |
|---------------|
| 673           |

## LAVABO DA APPOGGIO | Countertop washbasin | Aufsatzbecken | Vasque à poser | Lavabo de apoyo

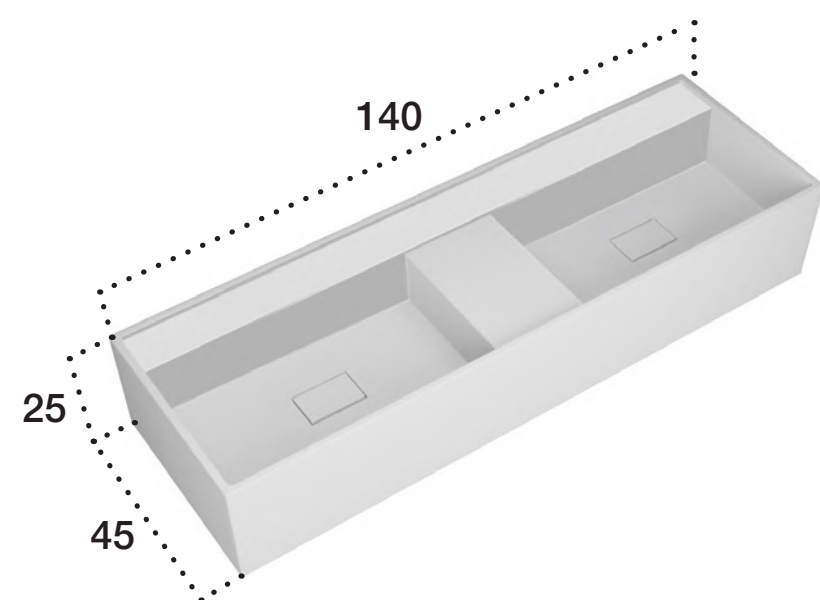

| Art.       | P  | L   | H  |
|------------|----|-----|----|
| <b>N51</b> | 45 | 140 | 25 |
| <b>N52</b> | 45 | 140 | 25 |

| Marmo 1      | Marmo 2      |
|--------------|--------------|
| Marble 1     | Marble 2     |
| <b>6.140</b> | <b>7.740</b> |

Accessori compresi / Included accessories

| Piletta / Waste | Copri piletta in finitura / Drain cover in finish | Troppo pieno / Overflow |
|-----------------|---|-------------------------|
| Art. 55F        | Cemento / Marmo 1 / Marmo 2                       | No                      |

Accessori suggeriti / suggested accessories

| Sifone / Trap |
|---------------|
| 673           |

## MINIMUM PIANI INTEGRATI | *Minimum built-in basins*

Minimum Waschtische mit integriertem Washbecken | Minimum plans vasque intégrée | Minimum encimeras integradas

**PIANO BISELLATO 45° CON LAVABO INTEGRATO IN CRISTALPLANT** | Bevelled 45° Cristalplant Biobased top with built-in basin | 45° abgechrägtes Waschtisch aus Cristalplant Biobased | Plans biseauté avec vasque intégrée en Cristalplant | Encimera biselada a 45° con lavabo integrado en Cristalplant Biobased

Versione CX | Central version

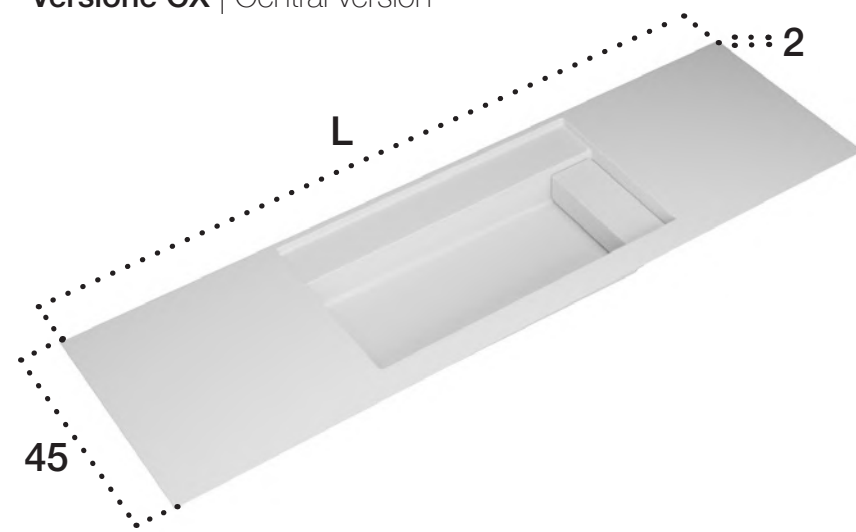

| Art. DX / RIGHT   | Art. CX / CENTRAL | Art. SX / LEFT    | P  | L   | H | Cristalplant |
|-------------------|-------------------|-------------------|----|-----|---|--------------|
| <b>N61</b> DX 120 | <b>N62</b> CX 120 | <b>N63</b> SX 120 | 45 | 120 | 2 | <b>2.630</b> |
| <b>N61</b> DX 140 | <b>N62</b> CX 140 | <b>N63</b> SX 140 | 45 | 140 | 2 | <b>2.740</b> |
| <b>N61</b> DX 160 | <b>N62</b> CX 160 | <b>N63</b> SX 160 | 45 | 160 | 2 | <b>2.870</b> |
| <b>N61</b> DX 180 | <b>N62</b> CX 180 | <b>N63</b> SX 180 | 45 | 180 | 2 | <b>2.890</b> |
| <b>N61</b> DX 200 | <b>N62</b> CX 200 | <b>N63</b> SX 200 | 45 | 200 | 2 | <b>3.390</b> |
| <b>N61</b> DX 220 | <b>N62</b> CX 220 | <b>N63</b> SX 220 | 45 | 220 | 2 | <b>3.560</b> |
| <b>N61</b> DX 300 | <b>N62</b> CX 300 | <b>N63</b> SX 300 | 45 | 300 | 2 | <b>3.940</b> |

Accessori compresi / Included accessories

|                                     |   |                               |
|-------------------------------------|---|-------------------------------|
| Piletta / Waste<br>Inclusa/Included | Copri piletta in finitura / Drain cover in finish<br>Cristalplant | Troppo pieno / Overflow<br>No |
|-------------------------------------|---|-------------------------------|

Accessori suggeriti / suggested accessories

|                      |
|----------------------|
| Sifone / Trap<br>673 |
|----------------------|



## MINIMUM PIANI INTEGRATI | *Minimum built-in basins*

Minimum Waschtische mit integriertem washbecken | Minimum plans vasque intégrée | Minimum encimeras integradas

**PIANO BISELLATO 45° PIANO CON LAVABO INTEGRATO IN MARMO** | Bevelled 45° Marble top with built-in basin | 45° abgechrägtes Waschtisch aus Marmor | Plans biseauté avec vasque intégrée en marbre | Encimera biselada a 45° con lavabo integrado en marmol

Versione CX | Central version

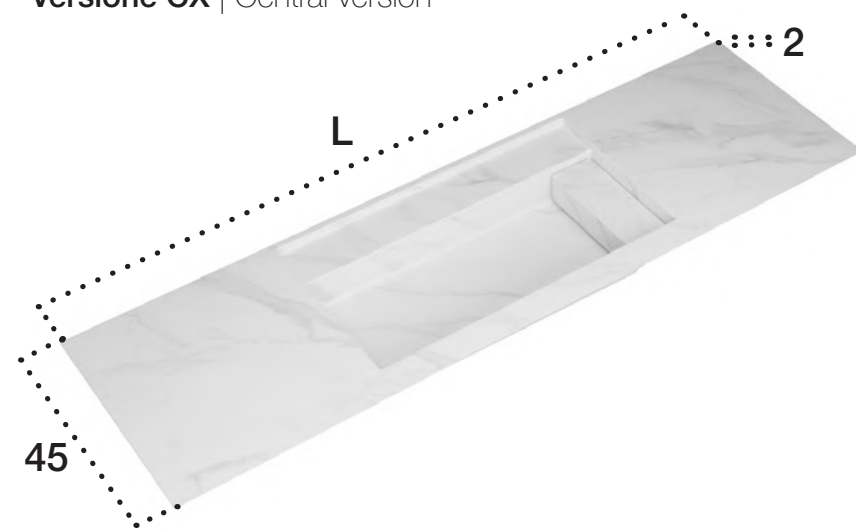

| Art. DX / RIGHT   | Art. CX / CENTRAL | Art. SX / LEFT    | P  | L   | H | Marmo 1<br>Marble 1 | Marmo 2<br>Marble 2 |
|-------------------|-------------------|-------------------|----|-----|---|---------------------|---------------------|
| <b>N64</b> DX 120 | <b>N65</b> CX 120 | <b>N66</b> SX 120 | 45 | 120 | 2 | <b>5.310</b>        | <b>6.810</b>        |
| <b>N64</b> DX 140 | <b>N65</b> CX 140 | <b>N66</b> SX 140 | 45 | 140 | 2 | <b>5.510</b>        | <b>7.110</b>        |
| <b>N64</b> DX 160 | <b>N65</b> CX 160 | <b>N66</b> SX 160 | 45 | 160 | 2 | <b>5.760</b>        | <b>7.360</b>        |
| <b>N64</b> DX 180 | <b>N65</b> CX 180 | <b>N66</b> SX 180 | 45 | 180 | 2 | <b>6.010</b>        | <b>7.660</b>        |
| <b>N64</b> DX 200 | <b>N65</b> CX 200 | <b>N66</b> SX 200 | 45 | 200 | 2 | <b>6.610</b>        | <b>8.360</b>        |
| <b>N64</b> DX 220 | <b>N65</b> CX 220 | <b>N66</b> SX 220 | 45 | 220 | 2 | <b>6.810</b>        | <b>8.660</b>        |
| <b>N64</b> DX 300 | <b>N65</b> CX 300 | <b>N66</b> SX 300 | 45 | 300 | 2 | <b>7.610</b>        | <b>9.820</b>        |

Accessori compresi / Included accessories

|                                     |  |                               |
|-------------------------------------|--|-------------------------------|
| Piletta / Waste<br>Inclusa/Included | Copri piletta in finitura / Drain cover in finish<br>Marmo 1 / Marmo 2 | Troppo pieno / Overflow<br>No |
|-------------------------------------|--|-------------------------------|

Accessori suggeriti / suggested accessories

|                      |
|----------------------|
| Sifone / Trap<br>673 |
|----------------------|



# MINIMUM BASI | *Minimum bases*

Minimum Basis | Minimum bases | Minimum bases

**FINITURE** | Finishes | Oberfläche | Finitions | Acabados

## Cat. 1 / Cat. 3

**LACCATI OPACHI E LUCIDI** | Matt and glossy painted | Matte und glänzende Lackierung | Lacqué opaque et brillant | Laqueados opacos y brillantes

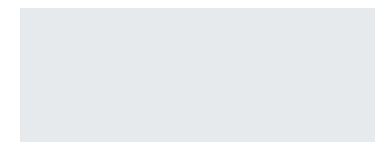

**B0 / BL**  
**Bianco**  
White  
Weiß  
Blanc  
Blanco

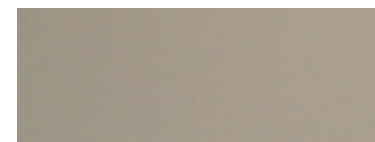

**GP / GL**  
**Grigio Pavillon**  
Pavillon grey  
Pavillon Grau  
Gris Pavillon  
Gris Pavillon



**PI / PA**  
**Pioggia**  
Rain  
Regen  
Pluie  
Lluvia



**GL / GM**  
**Grigio Londra**  
London grey  
London Grau  
Gris Londres  
Gris Londres



**EY / EZ**  
**Grigio Exclusive**  
Exclusive grey  
Exclusive Grau  
Gris Exclusive  
Gris Exclusive



**GF / GT**  
**Grafite**  
Graphite  
Graphit  
Graphite  
Grafito

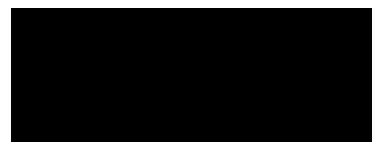

**N2 / N1**  
**Nero**  
Black  
Schwarz  
Noir  
Negro



**G5 / G6**  
**Grigio Bromo**  
Bromo grey  
Bromo Grau  
Gris Bromo  
Gris Bromo



**FA / FN**  
**Fango**  
Mud  
Schlamm  
Boue  
Barro



**VI / VN**  
**Visone**  
Mink  
Nerz  
Vison  
Vison



**AZ / A1**  
**Azzurro polvere**  
Blue powder  
Blau Puder  
Bleu poudre  
Azul pálido



**CA / CP**  
**Canapa**  
Hemp  
Hanf  
Chanvre  
Cáñamo



**S2 / S1**  
**Sabbia**  
Sand  
Sand  
Sable  
Arena



**C2 / C1**  
**Creta**  
Clay  
Ton  
Crête  
Creta



**C7 / C8**  
**Castoro Ottawa**  
Ottawa Beaver  
Biber-Farbe Ottawa  
Castor Ottawa  
Castor Ottawa



**CD / CL**  
**Argilla**  
Argilla  
Argilla  
Argilla  
Argilla



**FE / FR**  
**Ferro**  
Iron  
Eisen  
Fer  
Hierro



**V1 / V2**  
**Verde Comodoro**  
Green Commodore  
Commodore Grün  
Vert Commodore  
Verde Comodoro



**V7 / V8**  
**Verde Agave**  
Agave Green  
Agave Grau  
Vert Agave  
Verde Agave



**AV / AI**  
**Avio**  
Aviation  
Luftfahrt  
Aviation  
Aviación



**B7 / B8**  
**Blu Fes**  
Fes blue  
Blau Fes  
Bleu Fes  
Azul Fes

## Cat. 2

**LEGNI** | Woods | Holz | Bois | Maderas



**R4**  
**Rovere**  
Oak  
Eiche  
Rouvre  
Roble



**RP**  
**Rovere sbiancato**  
Bleached oak  
Gebleichte Eiche  
Rouvre blanchi  
Roble blanqueado



**RK**  
**Rovere Solid Skin**  
Solid Skin oak  
Eiche "Solid Skin"  
Rouvre "Solid Skin"  
Roble "Solid Skin"



**N8**  
**Noce naturale**  
Natural walnut  
Nussbaum Natur  
Noyer naturel  
Nogal naturales



**NC**  
**Noce Canaletto**  
Canaletto walnut  
Nussbaum Canaletto  
Noyer Canaletto  
Nogal Canaletto



**N6**  
**Noce bruciato**  
Walnut burned  
Nussbaum gebrannt  
Noyer brûlé  
Nogal quemado

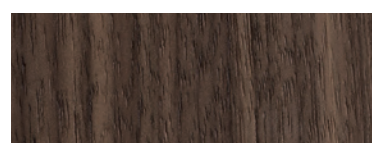

**NW**  
**Noce Brown**  
Walnut Brown  
Nussbaum braun  
Noyer Foncé  
Nogal marrón

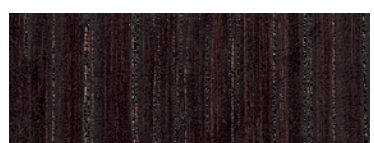

**W4**  
**Wengé**  
Wengé  
Wengé  
Wengé  
Wengué

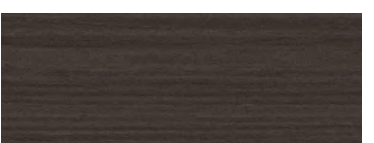

**Q1**  
**Alpi flamed grey**  
Alpi flamed grey  
Alpi flamed grey  
Alpi flamed grey  
Alpi flamed grey

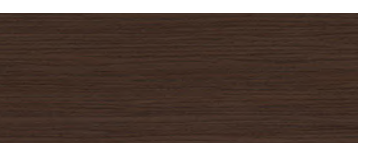

**Q2**  
**Alpi dark oak**  
Alpi dark oak  
Alpi dark oak  
Alpi dark oak  
Alpi dark oak

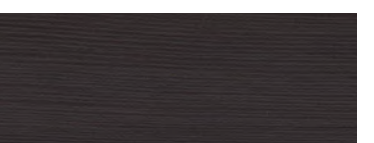

**Q3**  
**Alpi striped black XL**  
Alpi striped black XL  
Alpi striped black XL  
Alpi striped black XL  
Alpi striped black XL

## Marmi 1

**Marbles 1** | Marmor 1 | Marbre 1 | Marmor 1



**MC**  
**Carrara**  
Carrara  
Carrara  
Carrara  
Carrara



**MI**  
**Pietra Grey**  
Piedra gris  
Piedra gris  
Piedra gris  
Piedra gris

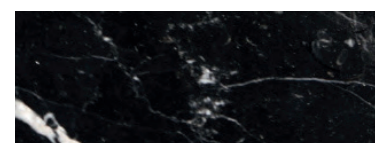

**MQ**  
**Nero Marquina**  
Nero Marquina  
Nero Marquina  
Nero Marquina  
Nero Marquina



**U1**  
**Jolie Grey**  
Jolie Grey  
Jolie Grey  
Jolie Grey  
Jolie Grey

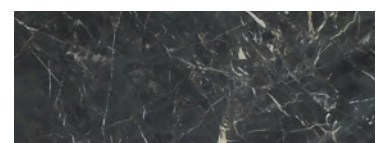

**U3**  
**Grey Saint Laurent**  
Grey Saint Laurent  
Grey Saint Laurent  
Grey Saint Laurent  
Grey Saint Laurent

## Marmi 2

**Marbles 2** | Marmor 2 | Marbre 2 | Marmor 2



**MR**  
**Statuario**  
Statuary  
Statuarisch  
Statuaire  
Estatuario



**MP**  
**Calacatta Gold**  
Calacatta Gold  
Calacatta Gold  
Calacatta Gold  
Calacatta Gold



**U2**  
**Noir Saint Laurent**  
Noir Saint Laurent  
Noir Saint Laurent  
Noir Saint Laurent  
Noir Saint Laurent



**U4**  
**Arabescato Corchia**  
Arabescato Corchia  
Arabescato Corchia  
Arabescato Corchia  
Arabescato Corchia

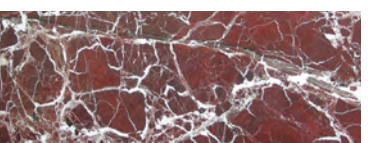

**U5**  
**Rosso Lepanto**  
Rosso Lepanto  
Rosso Lepanto  
Rosso Lepanto  
Rosso Lepanto

## MANIGLIE | *Handles*

Griffe | Poignés | Tirador

### MANIGLIA GOLA | Groove handle | Griffmulde | Poignée prise de main | Tirador gola



Art.

**D9A**

**Compresa  
Included**

### PREMI - APRI | "Press-and-open" handle | Griff "Drücken-Öffnen" | Poignée "ouverture pression" | Tirador "aprieta y abre"



Art.

**D9Q**

**Compresa  
Included**

**MANIGLIA GOLA** | Groove handle | Griffmulde | Poignée prise de main | Tirador gola



Art.

P L

**DQW**

45 30-160

**Ordinare il numero di cassetti legno corrispondenti al numero di cassetti presenti nel mobile. Nello stesso mobile non è possibile ordinare due tipi di cassetti (di serie e legno).** / Order the number of wooden drawers that corresponds to the number of drawers in the furniture. Two types of drawers in the same furniture cannot be ordered (standard or wood). / Bestellen Sie die Anzahl der Holzschubladen entsprechend der Anzahl der Schubladen im Möbelstück. Es ist nicht möglich, zwei verschiedene Schubladentypen (Standard und Holz) für das gleiche Möbel zu bestellen. / Commander le nombre de tiroirs en bois correspondant au nombre de tiroirs présents dans le meuble. Les tiroirs d'un même meuble ne peuvent pas être de deux types (de série et bois). / Colocar respectivamente el número establecido en los cajones de madera con el número de los cajones situados en el mueble. En el mismo mueble no se podrán colocar dos tipos de cajones distintos.(cajonera y de madera).

**Realizzabili in tutte le finiture Falper legno e laccato opaco. Specificare sempre all'atto dell'ordine.** / Drawers feasible in all Falper wooden and matt lacquered finishes. This must always be specified at the time of the order. / In allen Falper Holz- oder Mattlack-Farben möglich. Bitte stets bei der Bestellung die gewünschte Farbe angeben./ Les tiroirs sont réalisables dans toutes les finitions de bois et lacques opaque (gamme de couleurs Falper). Toujours spécifier au moment de la commande./ Los cajones se pueden conseguir en todos los acabados de madera y laqueado mate. Especificar siempre en el momento que realiza el pedido.

Cat. 1/2

Cad./Each **261**

**OPTIONAL PRESA ELETTRICA + 2 PRESE USB CON CABLAGGIO** | Optional electrical outlet + 2 USB sockets with wiring | Optional Stromsteckdose + 2 USB-Anschlüsse mit verkabelung | Option prise électrique + 2 prise USB avec cablage | Opcional enchufe eléctrico + 2 tomas USB con cableado

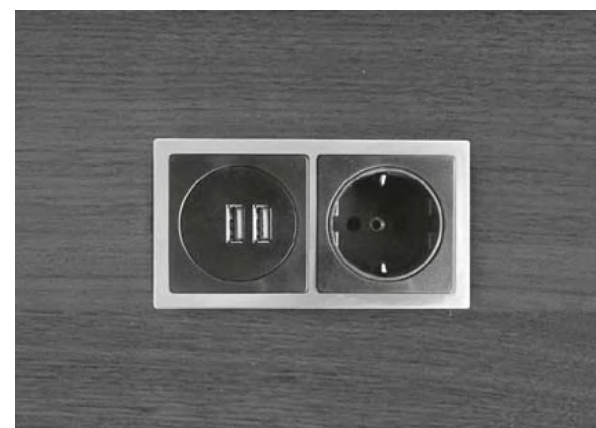

Art.

**Q83 DX • Q84 SX**

**Q86 DX • Q87 SX**

Con presa elettrica svizzera/CH outlet / with Swiss outlet / Mit CH Stromsteckdose / Avec prise électrique Suisse / Opcional enchufe eléctrico suizo

**Posizionabile su cassetti inferiori (max L. 90) a destra o sinistra**

This option can be positioned on lower drawers (max L. 90) on the right or left  
Positionierbar an den unteren Schubladen (L. max. 90) rechts oder links  
Peut être placé dans les tiroirs inférieurs (max L. 90) à droite ou à gauche  
Puede colocarse en cajones inferiores (L. max. 90) a la derecha o a la izquierda

Prezzo

Cad./Each **414**

Cad./Each **414**

**OPTIONAL DOPPIA PRESA ELETTRICA CON CABLAGGIO** | Optional two electrical outlets with wiring | Optional Doppeltromsteckdose mit verkabelung | Option double prise électrique avec cablage | Opcional doble enchufe eléctrico con cableado



Art.

**Q81 DX • Q82 SX**

**Q93 DX • Q94 SX**

Con presa elettrica svizzera/CH outlet / with Swiss outlet / Mit CH Stromsteckdose / Avec prise électrique Suisse / Opcional enchufe eléctrico suizo

**Posizionabile su cassetti inferiori (max L. 90) a destra o sinistra**

This option can be positioned on lower drawers (max L. 90) on the right or left  
Positionierbar an den unteren Schubladen (L. max. 90) rechts oder links  
Peut être placé dans les tiroirs inférieurs (max L. 90) à droite ou à gauche  
Puede colocarse en cajones inferiores (L. max. 90) a la derecha o a la izquierda

Prezzo

Cad./Each **309**

Cad./Each **309**

# MINIMUM BASI | *Minimum bases*

Minimum Basis| Minimum bases| Minimum bases

# H 25

**BASE componibile laterale SX, 1 cassetto con top in legno** | Left hand modular unit with 1 drawer and wooden top | Modulare basis linke Version, 1 Schublade und Holzplatte | Base modulaire gauche avec 1 tiroir et top en bois | Modulo componibile izquierdo con 1 cajon y encimera de madera

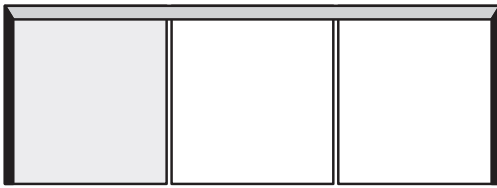
| Art.           | P  | L   | H  |   | Cat. 1 | Cat. 2 | Cat. 3 |
|----------------|----|-----|----|---|--------|--------|--------|
| <b>N71</b> 60  | 45 | 60  | 25 |  | 700    | 910    | 820    |
| <b>N71</b> 80  |    | 80  | 25 |   | 830    | 1.050  | 970    |
| <b>N71</b> 100 |    | 100 | 25 |   | 950    | 1.210  | 1.120  |
| <b>N71</b> 120 |    | 120 | 25 |   | 1.060  | 1.360  | 1.280  |
| <b>N71</b> 140 |    | 140 | 25 |   | 1.190  | 1.520  | 1.400  |
| <b>N71</b> 160 |    | 160 | 25 |   | 1.330  | 1.660  | 1.540  |

**BASE componibile centrale, 1 cassetto con top in legno** | Central modular unit with 1 drawer and wooden top | Modulare Basis mittige Version, 1 Schublade und Holzplatte | Base modulaire centrale avec 1 tiroir et top en bois | Modulo componibile central con 1 cajon y encimera de madera

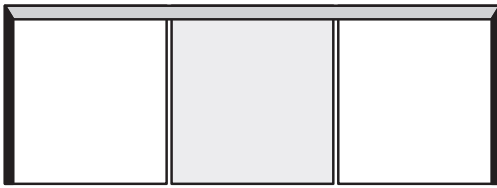
| Art.           | P  | L   | H  |  | Cat. 1 | Cat. 2 | Cat. 3 |
|----------------|----|-----|----|--|--------|--------|--------|
| <b>N73</b> 60  | 45 | 60  | 25 |  | 480    | 620    | 540    |
| <b>N73</b> 80  |    | 80  | 25 |  | 540    | 690    | 620    |
| <b>N73</b> 100 |    | 100 | 25 |  | 610    | 790    | 710    |
| <b>N73</b> 120 |    | 120 | 25 |  | 670    | 860    | 800    |
| <b>N73</b> 140 |    | 140 | 25 |  | 570    | 950    | 850    |
| <b>N73</b> 160 |    | 160 | 25 |  | 830    | 1.030  | 920    |

**BASE componibile laterale DX, 1 cassetto con top in legno** | Right hand modular unit with 1 drawer and wooden top | Modulare Basis rechte Version, 1 Schublade und Holzplatte | Base modulaire droite avec 1 tiroir et top en bois | Modulo componibile derecho con 1 cajon y encimera de madera

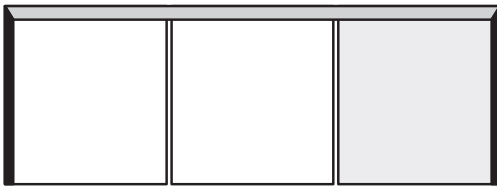
| Art.           | P  | L   | H  |   | Cat. 1 | Cat. 2 | Cat. 3 |
|----------------|----|-----|----|---|--------|--------|--------|
| <b>N75</b> 60  | 45 | 60  | 25 |  | 700    | 910    | 820    |
| <b>N75</b> 80  |    | 80  | 25 |   | 830    | 1.050  | 970    |
| <b>N75</b> 100 |    | 100 | 25 |   | 950    | 1.210  | 1.120  |
| <b>N75</b> 120 |    | 120 | 25 |   | 1.060  | 1.360  | 1.280  |
| <b>N75</b> 140 |    | 140 | 25 |   | 1.190  | 1.520  | 1.400  |
| <b>N75</b> 160 |    | 160 | 25 |   | 1.330  | 1.660  | 1.540  |

**BASE COMPLETA, 1 CASSETTO CON TOP IN LEGNO** | Complete unit with 1 drawer and wooden top | Unterschrank 1 Schublade und Holzplatte | Base avec 1 tiroir et top en bois | Modulo con 1 cajon y encimera de madera

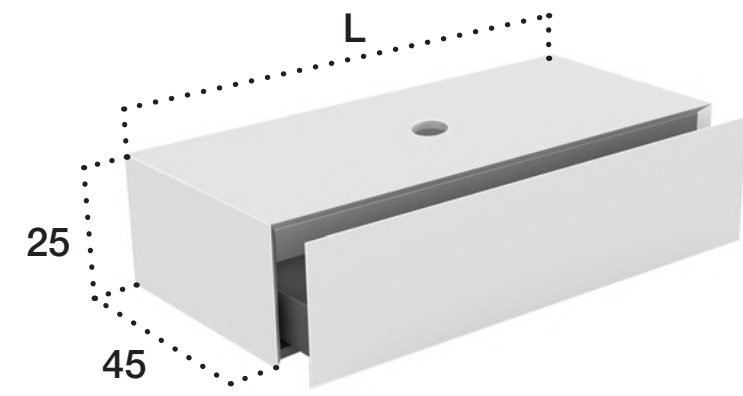

| Art.           | P  | L   | H  |
|----------------|----|-----|----|
| <b>N7G 60</b>  | 45 | 60  | 25 |
| <b>N7G 80</b>  |    | 80  | 25 |
| <b>N7G 100</b> |    | 100 | 25 |
| <b>N7G 120</b> |    | 120 | 25 |
| <b>N7G 140</b> |    | 140 | 25 |
| <b>N7G 160</b> |    | 160 | 25 |

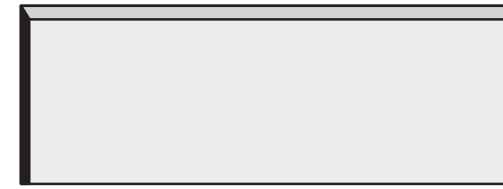

| Cat. 1     | Cat. 2       | Cat. 3       |
|------------|--------------|--------------|
| <b>630</b> | <b>770</b>   | <b>710</b>   |
| <b>690</b> | <b>850</b>   | <b>790</b>   |
| <b>770</b> | <b>940</b>   | <b>870</b>   |
| <b>830</b> | <b>1.010</b> | <b>970</b>   |
| <b>900</b> | <b>1.110</b> | <b>1.010</b> |
| <b>990</b> | <b>1.180</b> | <b>1.090</b> |

**BASE COMPONENTE LATERALE SX, 1 CASSETTO CON TOP IN MARMO 1** | Left hand modular unit with 1 drawer and marble 1 top | Modulare Basis linke Version, 1 Schublade und Platte aus Marmor 1 | Base modulaire gauche avec 1 tiroir et top en marbre 1 | Modulo componibile izquierdo con 1 cajon y encimera de marmol 1

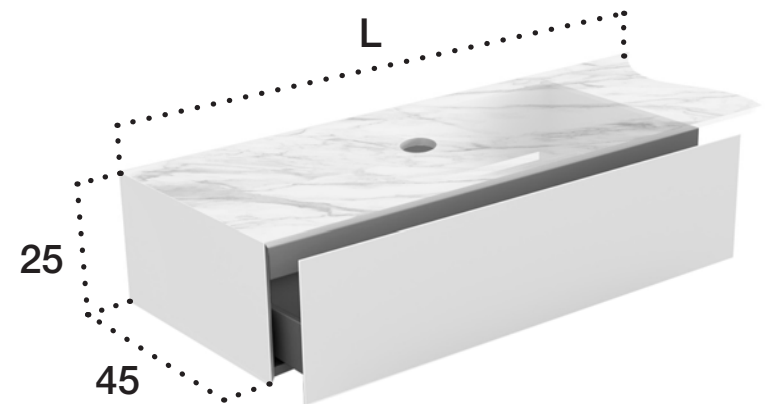
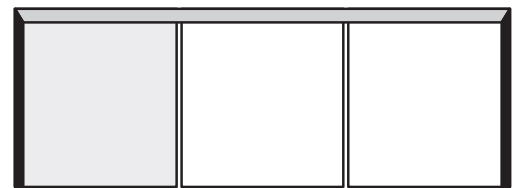
| Art.  | P  | L   | H  |   | Cat. 1       | Cat. 2       | Cat. 3       |
|---|----|-----|----|---|--------------|--------------|--------------|
|  |    |     |    |  |              |              |              |
| <b>N7A 60</b>   | 45 | 60  | 25 |   | <b>1.530</b> | <b>1.670</b> | <b>1.610</b> |
| <b>N7A 80</b>   |    | 80  | 25 |   | <b>1.760</b> | <b>1.910</b> | <b>1.850</b> |
| <b>N7A 100</b>  |    | 100 | 25 |   | <b>1.990</b> | <b>2.160</b> | <b>2.100</b> |
| <b>N7A 120</b>  |    | 120 | 25 |   | <b>2.210</b> | <b>2.400</b> | <b>2.350</b> |
| <b>N7A 140</b>  |    | 140 | 25 |   | <b>2.450</b> | <b>2.650</b> | <b>2.560</b> |
| <b>N7A 160</b>  |    | 160 | 25 |   | <b>2.690</b> | <b>2.890</b> | <b>2.800</b> |

**BASE COMPONENTE CENTRALE, 1 CASSETTO CON TOP IN MARMO 1** | Central modular unit with 1 drawer and top in marble 1 | Modulare Basis mittige Version, 1 Schublade und Platte aus Marmor 1 | Base modulaire centrale avec 1 tiroir et top en marbre 1 | Modulo componibile central con 1 cajon y encimera de marmol 1

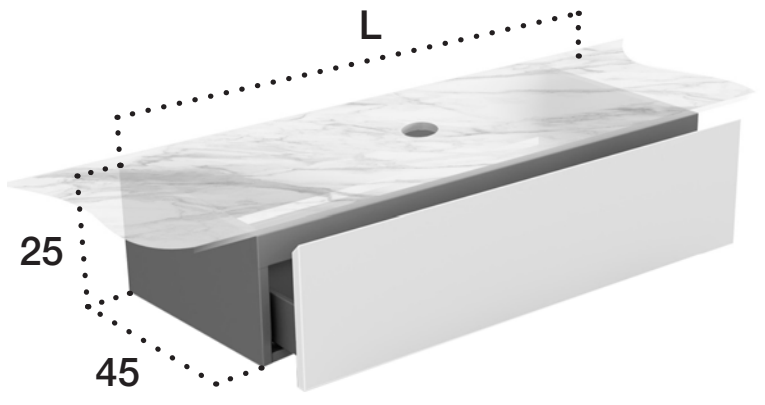
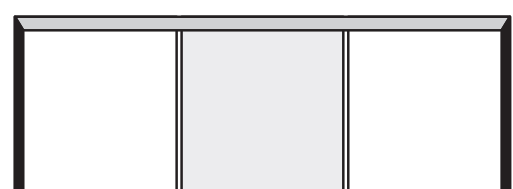
| Art.   | P  | L   | H  |  | Cat. 1       | Cat. 2       | Cat. 3       |
|--|----|-----|----|--|--------------|--------------|--------------|
|  |    |     |    |  |              |              |              |
| <b>N7C 60</b>  | 45 | 60  | 25 |  | <b>1.460</b> | <b>1.610</b> | <b>1.530</b> |
| <b>N7C 80</b>  |    | 80  | 25 |  | <b>1.690</b> | <b>1.840</b> | <b>1.770</b> |
| <b>N7C 100</b>   |    | 100 | 25 |  | <b>1.920</b> | <b>2.100</b> | <b>2.020</b> |
| <b>N7C 120</b>   |    | 120 | 25 |  | <b>2.140</b> | <b>2.330</b> | <b>2.270</b> |
| <b>N7C 140</b>   |    | 140 | 25 |  | <b>2.380</b> | <b>2.590</b> | <b>2.480</b> |
| <b>N7C 160</b>   |    | 160 | 25 |  | <b>2.630</b> | <b>2.820</b> | <b>2.710</b> |

**BASE COMPONENTE LATERALE DX, 1 CASSETTO CON TOP IN MARMO 1** | Right hand modular unit with 1 drawer and marble 1 top | Modulare Basis rechte Version, 1 Schublade und Platte aus Marmor 1 | Base modulaire droite avec 1 tiroir et top en marbre 1 | Modulo componibile derecho con 1 cajon y encimera en marmol 1

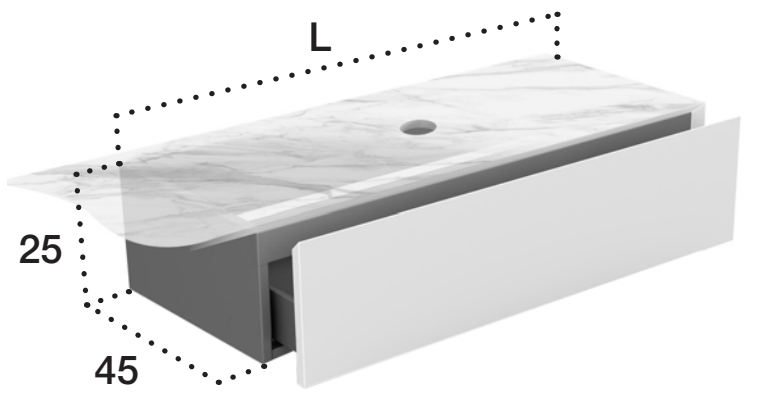
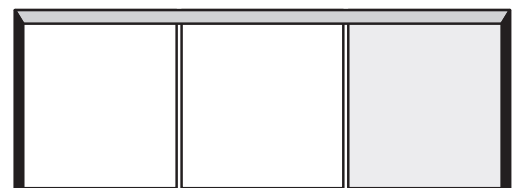
| Art.  | P  | L   | H  |   | Cat. 1       | Cat. 2       | Cat. 3       |
|---|----|-----|----|---|--------------|--------------|--------------|
|  |    |     |    |  |              |              |              |
| <b>N7E 60</b>   | 45 | 60  | 25 |   | <b>1.530</b> | <b>1.670</b> | <b>1.610</b> |
| <b>N7E 80</b>   |    | 80  | 25 |   | <b>1.760</b> | <b>1.910</b> | <b>1.850</b> |
| <b>N7E 100</b>  |    | 100 | 25 |   | <b>1.990</b> | <b>2.160</b> | <b>2.100</b> |
| <b>N7E 120</b>  |    | 120 | 25 |   | <b>2.210</b> | <b>2.400</b> | <b>2.350</b> |
| <b>N7E 140</b>  |    | 140 | 25 |   | <b>2.450</b> | <b>2.650</b> | <b>2.560</b> |
| <b>N7E 160</b>  |    | 160 | 25 |   | <b>2.690</b> | <b>2.890</b> | <b>2.800</b> |



**BASE COMPLETA, 1 CASSETTO CON TOP IN MARMO 1** | Complete unit with 1 drawer and marble 1 top | Unterschrank 1 Schublade und Platte aus Marmor 1 | Base avec 1 tiroir et top en marbre 1 | Modulo con 1 cajon y encimera en marmol 1

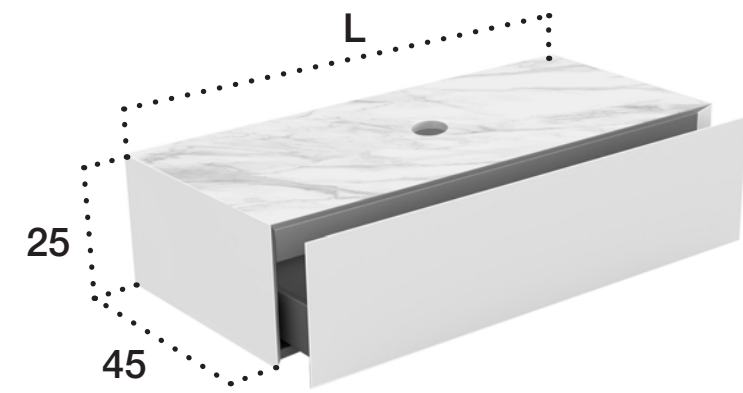

| Art.           | P  | L   | H  |
|----------------|----|-----|----|
| <b>N7J 60</b>  | 45 | 60  | 25 |
| <b>N7J 80</b>  |    | 80  | 25 |
| <b>N7J 100</b> |    | 100 | 25 |
| <b>N7J 120</b> |    | 120 | 25 |
| <b>N7J 140</b> |    | 140 | 25 |
| <b>N7J 160</b> |    | 160 | 25 |

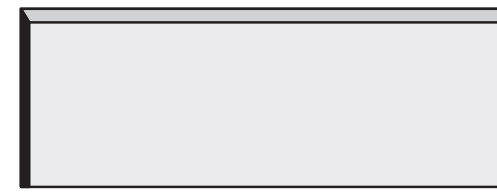

| Cat. 1       | Cat. 2       | Cat. 3       |
|--------------|--------------|--------------|
| <b>1.620</b> | <b>1.760</b> | <b>1.690</b> |
| <b>1.840</b> | <b>2.000</b> | <b>1.940</b> |
| <b>2.080</b> | <b>2.250</b> | <b>2.180</b> |
| <b>2.300</b> | <b>2.490</b> | <b>2.440</b> |
| <b>2.530</b> | <b>2.740</b> | <b>2.650</b> |
| <b>2.780</b> | <b>2.980</b> | <b>2.880</b> |

**BASE COMPONENTE LATERALE SX, 1 CASSETTO CON TOP IN MARMO 2** | Left hand modular unit with 1 drawer and marble 2 top | Modulare Basis linke Version, 1 Schublade und Platte aus Marmor 2 | Base modulaire gauche avec 1 tiroir et top en marbre 2 | Modulo componibile izquierdo con 1 cajon y encimera de marmol 2

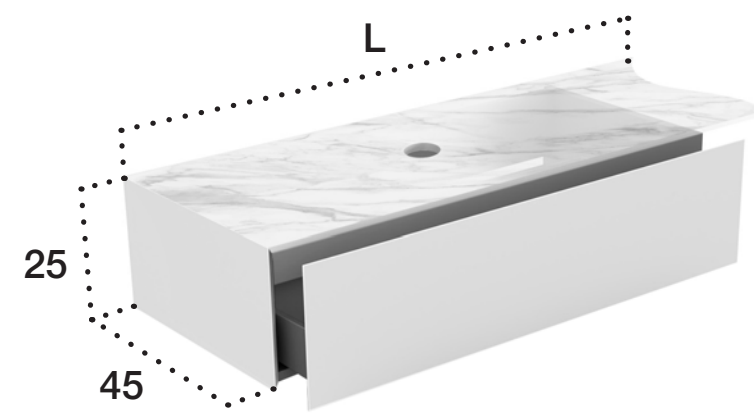

| Art.           | P  | L   | H  |
|----------------|----|-----|----|
| <b>N72 60</b>  | 45 | 60  | 25 |
| <b>N72 80</b>  |    | 80  | 25 |
| <b>N72 100</b> |    | 100 | 25 |
| <b>N72 120</b> |    | 120 | 25 |
| <b>N72 140</b> |    | 140 | 25 |
| <b>N72 160</b> |    | 160 | 25 |

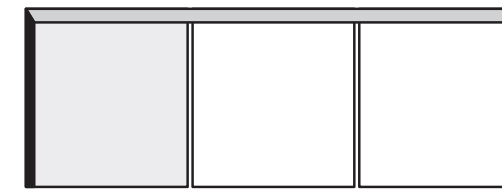

| Cat. 1       | Cat. 2       | Cat. 3       |
|--------------|--------------|--------------|
| <b>2.140</b> | <b>2.280</b> | <b>2.210</b> |
| <b>2.570</b> | <b>2.710</b> | <b>2.650</b> |
| <b>3.000</b> | <b>3.170</b> | <b>3.100</b> |
| <b>3.420</b> | <b>3.610</b> | <b>3.560</b> |
| <b>3.860</b> | <b>4.070</b> | <b>3.970</b> |
| <b>4.310</b> | <b>4.500</b> | <b>4.410</b> |

**BASE COMPONENTE CENTRALE, 1 CASSETTO CON TOP IN MARMO 2** | Central modular unit with 1 drawer and top in marble 2 | Modulare Basis mittige Version, 1 Schublade und Platte aus Marmor 2 | Base modulaire centrale avec 1 tiroir et top en marbre 2 | Modulo componibile central con 1 cajon y encimera de marmol 2

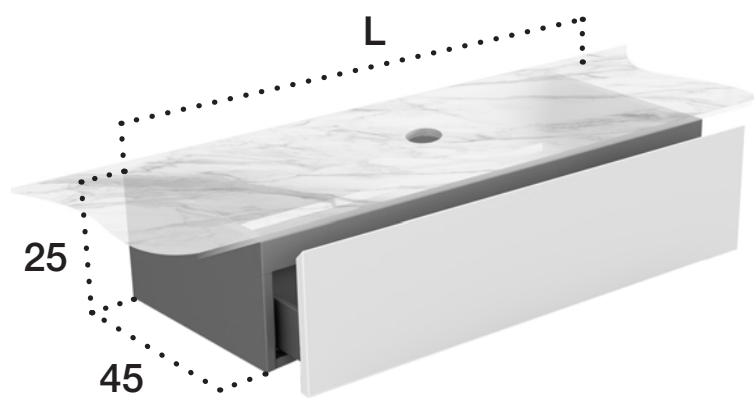

| Art.           | P  | L   | H  |
|----------------|----|-----|----|
| <b>N74 60</b>  | 45 | 60  | 25 |
| <b>N74 80</b>  |    | 80  | 25 |
| <b>N74 100</b> |    | 100 | 25 |
| <b>N74 120</b> |    | 120 | 25 |
| <b>N74 140</b> |    | 140 | 25 |
| <b>N74 160</b> |    | 160 | 25 |

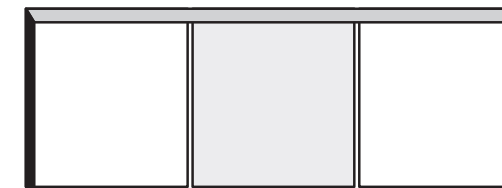

| Cat. 1       | Cat. 2       | Cat. 3       |
|--------------|--------------|--------------|
| <b>2.070</b> | <b>2.210</b> | <b>2.130</b> |
| <b>2.500</b> | <b>2.650</b> | <b>2.570</b> |
| <b>2.930</b> | <b>3.100</b> | <b>3.020</b> |
| <b>3.350</b> | <b>3.540</b> | <b>3.480</b> |
| <b>3.790</b> | <b>4.000</b> | <b>3.890</b> |
| <b>4.240</b> | <b>4.440</b> | <b>4.330</b> |

**BASE COMPONENTE LATERALE DX, 1 CASSETTO CON TOP IN MARMO 2** | Right hand modular unit with 1 drawer and marble 2 top | Modulare Basis rechte Version, 1 Schublade und Platte aus Marmor 2 | Base modulaire droite avec 1 tiroir et top en marbre 2 | Modulo componibile derecho con 1 cajon y encimera en marmol 2

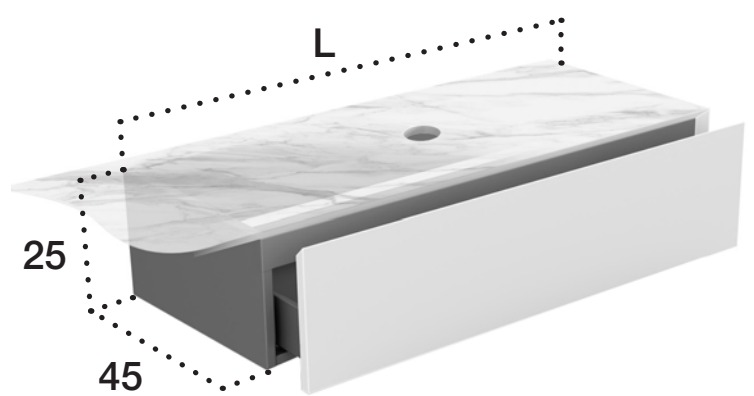

| Art.           | P  | L   | H  |
|----------------|----|-----|----|
| <b>N76 60</b>  | 45 | 60  | 25 |
| <b>N76 80</b>  |    | 80  | 25 |
| <b>N76 100</b> |    | 100 | 25 |
| <b>N76 120</b> |    | 120 | 25 |
| <b>N76 140</b> |    | 140 | 25 |
| <b>N76 160</b> |    | 160 | 25 |

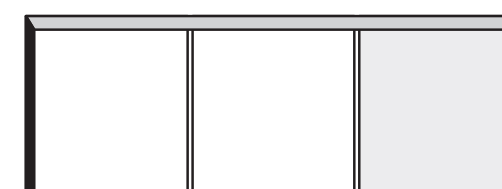

| Cat. 1       | Cat. 2       | Cat. 3       |
|--------------|--------------|--------------|
| <b>2.140</b> | <b>2.280</b> | <b>2.210</b> |
| <b>2.570</b> | <b>2.710</b> | <b>2.650</b> |
| <b>3.000</b> | <b>3.170</b> | <b>3.100</b> |
| <b>3.420</b> | <b>3.610</b> | <b>3.560</b> |
| <b>3.860</b> | <b>4.070</b> | <b>3.970</b> |
| <b>4.310</b> | <b>4.500</b> | <b>4.410</b> |

**BASE COMPLETA, 1 CASSETTO CON TOP IN MARMO 2** | Complete unit with 1 drawer and marble 2 top | Unterschrank 1 Schublade und Platte aus Marmor 2 | Base avec 1 tiroir et top en marbre 2 |Modulo con 1 cajon y encimera en marmol 2

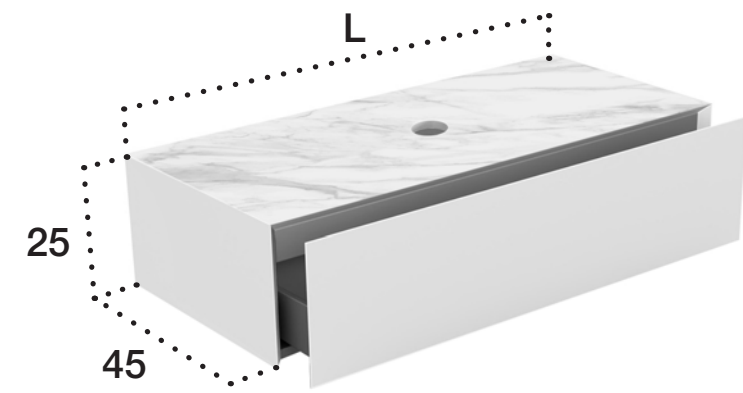

| Art.    | P  | L   | H  |
|---------|----|-----|----|
| N77 60  | 45 | 60  | 25 |
| N77 80  |    | 80  | 25 |
| N77 100 |    | 100 | 25 |
| N77 120 |    | 120 | 25 |
| N77 140 |    | 140 | 25 |
| N77 160 |    | 160 | 25 |

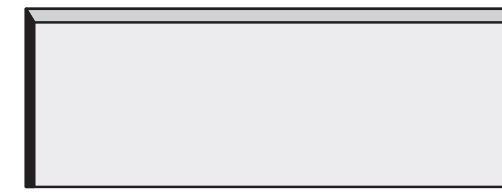

| Cat. 1 | Cat. 2 | Cat. 3 |
|--------|--------|--------|
| 2.220  | 2.370  | 2.300  |
| 2.650  | 2.800  | 2.740  |
| 3.080  | 3.260  | 3.190  |
| 3.510  | 3.700  | 3.650  |
| 3.940  | 4.150  | 4.060  |
| 4.390  | 4.590  | 4.500  |

**BASE componibile laterale SX, 1 cassetto con top in legno** | Left hand modular unit with 1 drawer and wooden top | Modulare basis linke Version, 1 Schublade und Holzplatte | Base modulaire gauche avec 1 tiroir et top en bois | Modulo componibile izquierdo con 1 cajon y encimera de madera

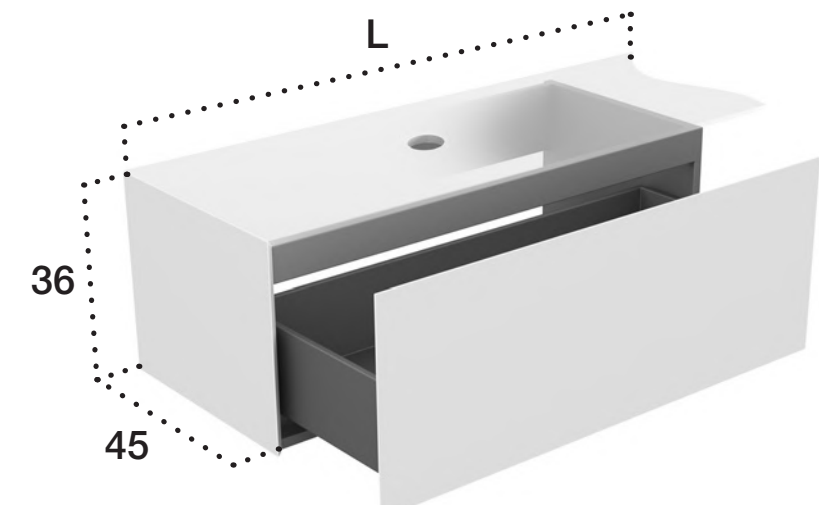
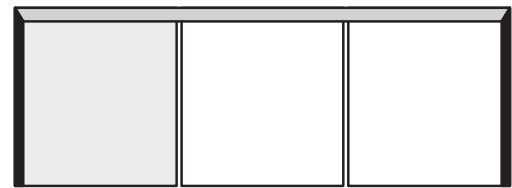
|   |         |    |     |    |   |        |        |        |
|---|---------|----|-----|----|---|--------|--------|--------|
|  | Art.    | P  | L   | H  |   | Cat. 1 | Cat. 2 | Cat. 3 |
|   | N81 60  | 45 | 60  | 36 |  | 620    | 800    | 750    |
|   | N81 80  |    | 80  | 36 |   | 690    | 870    | 830    |
|   | N81 100 |    | 100 | 36 |   | 760    | 970    | 910    |
|   | N81 120 |    | 120 | 36 |   | 820    | 1.040  | 1.010  |
|   | N81 140 |    | 140 | 36 |   | 890    | 1.140  | 1.060  |
|   | N81 160 |    | 160 | 36 |   | 980    | 1.210  | 1.130  |

**BASE componibile centrale, 1 cassetto con top in legno** | Central modular unit with 1 drawer and wooden top | Modulare Basis mittige Version, 1 Schublade und Holzplatte | Base modulaire centrale avec 1 tiroir et top en bois | Modulo componibile central con 1 cajon y encimera de madera

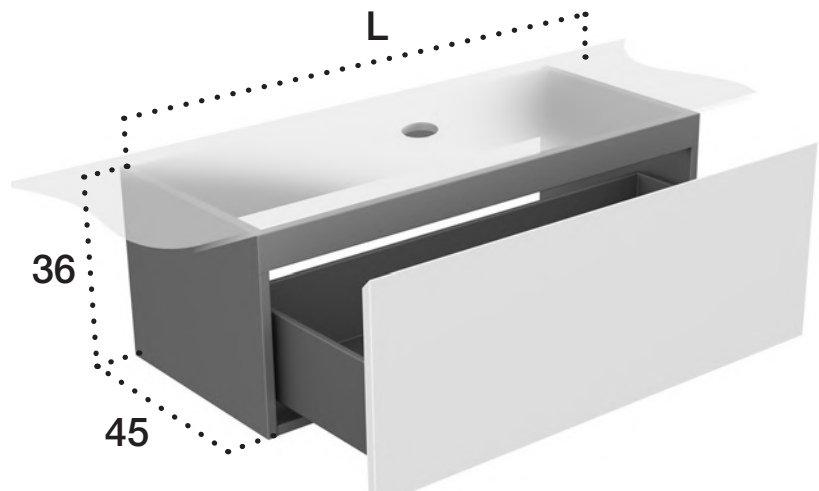
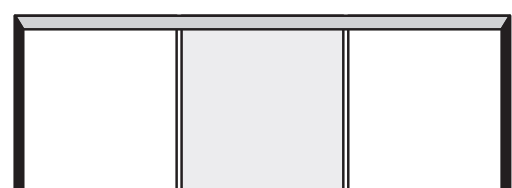
|  |         |    |     |    |  |        |        |        |
|--|---------|----|-----|----|--|--------|--------|--------|
|  | Art.    | P  | L   | H  |  | Cat. 1 | Cat. 2 | Cat. 3 |
|  | N83 60  | 45 | 60  | 36 |  | 520    | 660    | 590    |
|  | N83 80  |    | 80  | 36 |  | 580    | 730    | 670    |
|  | N83 100 |    | 100 | 36 |  | 650    | 830    | 760    |
|  | N83 120 |    | 120 | 36 |  | 710    | 900    | 850    |
|  | N83 140 |    | 140 | 36 |  | 790    | 990    | 900    |
|  | N83 160 |    | 160 | 36 |  | 870    | 1.070  | 970    |

**BASE componibile laterale DX, 1 cassetto con top in legno** | Right hand modular unit with 1 drawer and wooden top | Modulare Basis rechte Version, 1 Schublade und Holzplatte | Base modulaire droite avec 1 tiroir et top en bois | Modulo componibile derecho con 1 cajon y encimera de madera

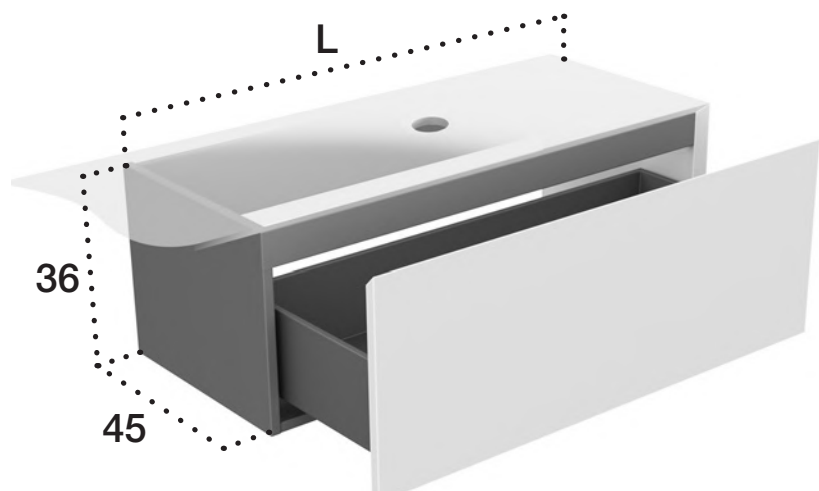
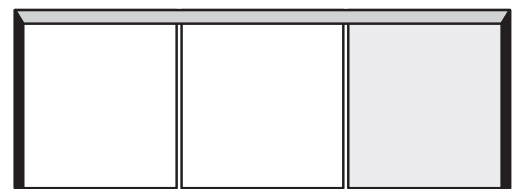
|   |         |    |     |    |   |        |        |        |
|---|---------|----|-----|----|---|--------|--------|--------|
|  | Art.    | P  | L   | H  |   | Cat. 1 | Cat. 2 | Cat. 3 |
|   | N85 60  | 45 | 60  | 36 |  | 620    | 800    | 750    |
|   | N85 80  |    | 80  | 36 |   | 690    | 870    | 830    |
|   | N85 100 |    | 100 | 36 |   | 760    | 970    | 910    |
|   | N85 120 |    | 120 | 36 |   | 820    | 1.040  | 1.010  |
|   | N85 140 |    | 140 | 36 |   | 890    | 1.140  | 1.060  |
|   | N85 160 |    | 160 | 36 |   | 980    | 1.210  | 1.130  |

**BASE COMPLETA, 1 CASSETTO CON TOP IN LEGNO** | Complete unit with 1 drawer and wooden top | Unterschrank 1 Schublade und Holzplatte | Base avec 1 tiroir et top en bois |Modulo con 1 cajon y encimera de madera

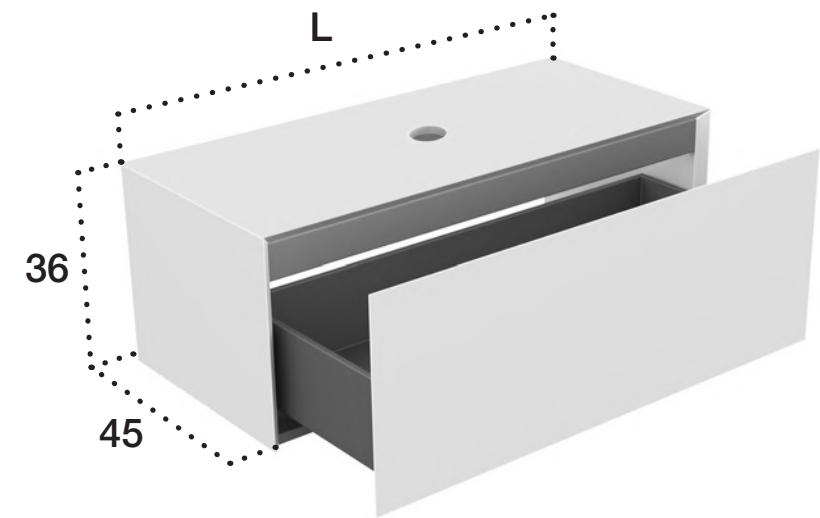

| Art.           | P  | L   | H  |
|----------------|----|-----|----|
| <b>N8R 60</b>  | 45 | 60  | 36 |
| <b>N8R 80</b>  |    | 80  | 36 |
| <b>N8R 100</b> |    | 100 | 36 |
| <b>N8R 120</b> |    | 120 | 36 |
| <b>N8R 140</b> |    | 140 | 36 |
| <b>N8R 160</b> |    | 160 | 36 |

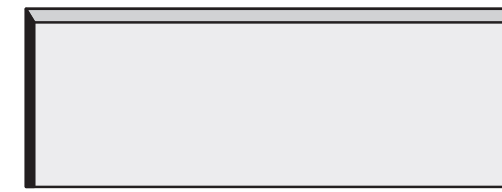

| Cat. 1 | Cat. 2 | Cat. 3 |
|--------|--------|--------|
| 710    | 890    | 870    |
| 770    | 960    | 950    |
| 850    | 1.060  | 1.040  |
| 910    | 1.130  | 1.140  |
| 980    | 1.220  | 1.180  |
| 1.070  | 1.300  | 1.260  |

**BASE COMPONENTE LATERALE SX, 1 CASSETTO CON TOP IN MARMO 1** | Left hand modular unit with 1 drawer and marble 1 top | Modulare Basis linke Version, 1 Schublade und Platte aus Marmor 1 | Base modulaire gauche avec 1 tiroir et top en marbre 1 | Modulo componibile izquierdo con 1 cajon y encimera de marmol 1

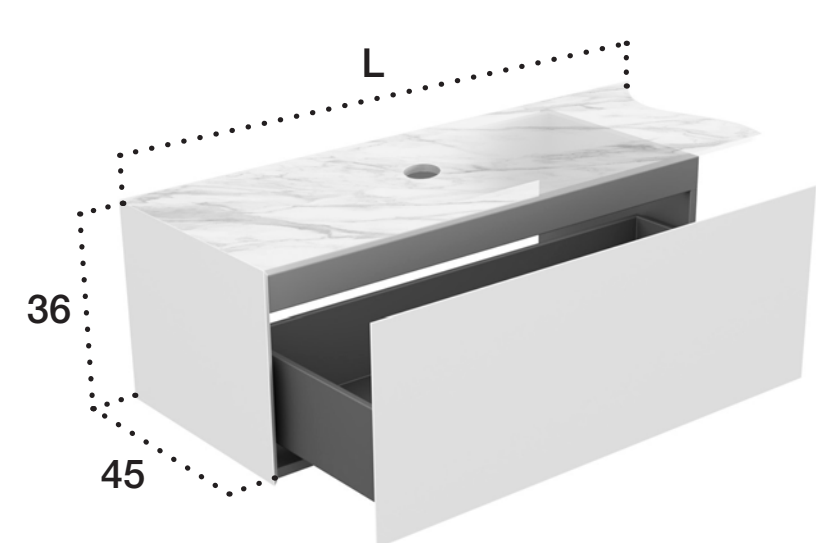

| Art.           | P  | L   | H  |
|----------------|----|-----|----|
| <b>N8L 60</b>  | 45 | 60  | 36 |
| <b>N8L 80</b>  |    | 80  | 36 |
| <b>N8L 100</b> |    | 100 | 36 |
| <b>N8L 120</b> |    | 120 | 36 |
| <b>N8L 140</b> |    | 140 | 36 |
| <b>N8L 160</b> |    | 160 | 36 |



| Cat. 1       | Cat. 2       | Cat. 3       |
|--------------|--------------|--------------|
| <b>1.610</b> | <b>1.790</b> | <b>1.730</b> |
| <b>1.840</b> | <b>2.020</b> | <b>1.980</b> |
| <b>2.070</b> | <b>2.280</b> | <b>2.220</b> |
| <b>2.290</b> | <b>2.510</b> | <b>2.480</b> |
| <b>2.530</b> | <b>2.770</b> | <b>2.690</b> |
| <b>2.780</b> | <b>3.000</b> | <b>2.920</b> |

**BASE COMPONENTE CENTRALE, 1 CASSETTO CON TOP IN MARMO 1** | Central modular unit with 1 drawer and top in marble 1 | Modulare Basis mittige Version, 1 Schublade und Platte aus Marmor 1 | Base modulaire centrale avec 1 tiroir et top en marbre 1 | Modulo componibile central con 1 cajon y encimera de marmol 1

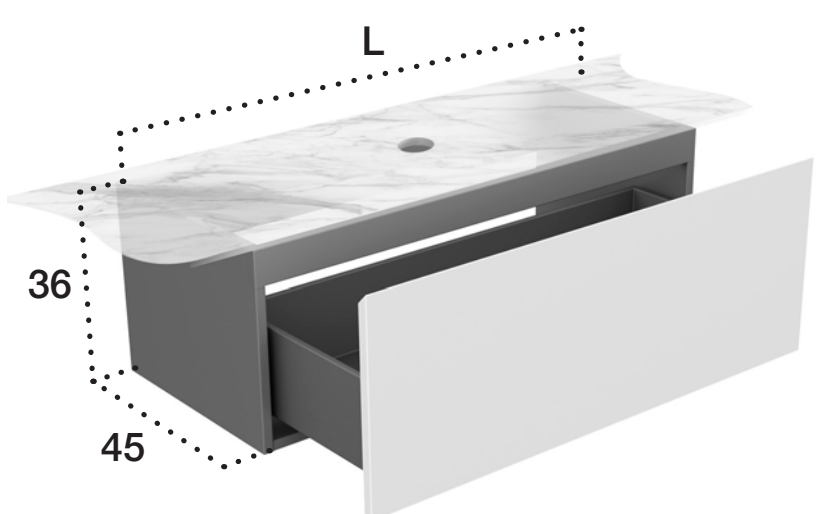

| Art.           | P  | L   | H  |
|----------------|----|-----|----|
| <b>N8N 60</b>  | 45 | 60  | 36 |
| <b>N8N 80</b>  |    | 80  | 36 |
| <b>N8N 100</b> |    | 100 | 36 |
| <b>N8N 120</b> |    | 120 | 36 |
| <b>N8N 140</b> |    | 140 | 36 |
| <b>N8N 160</b> |    | 160 | 36 |

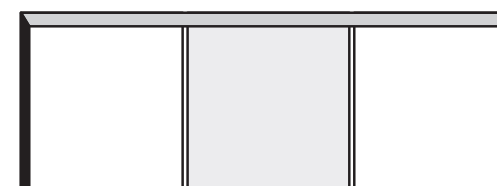

| Cat. 1       | Cat. 2       | Cat. 3       |
|--------------|--------------|--------------|
| <b>1.510</b> | <b>1.650</b> | <b>1.580</b> |
| <b>1.730</b> | <b>1.880</b> | <b>1.820</b> |
| <b>1.960</b> | <b>2.140</b> | <b>2.070</b> |
| <b>2.180</b> | <b>2.370</b> | <b>2.330</b> |
| <b>2.420</b> | <b>2.630</b> | <b>2.530</b> |
| <b>2.670</b> | <b>2.860</b> | <b>2.770</b> |

**BASE COMPONENTE LATERALE DX, 1 CASSETTO CON TOP IN MARMO 1** | Right hand modular unit with 1 drawer and marble 1 top | Modulare Basis rechte Version, 1 Schublade und Platte aus Marmor 1 | Base modulaire droite avec 1 tiroir et top en marbre 1 | Modulo componibile derecho con 1 cajon y encimera en marmol 1

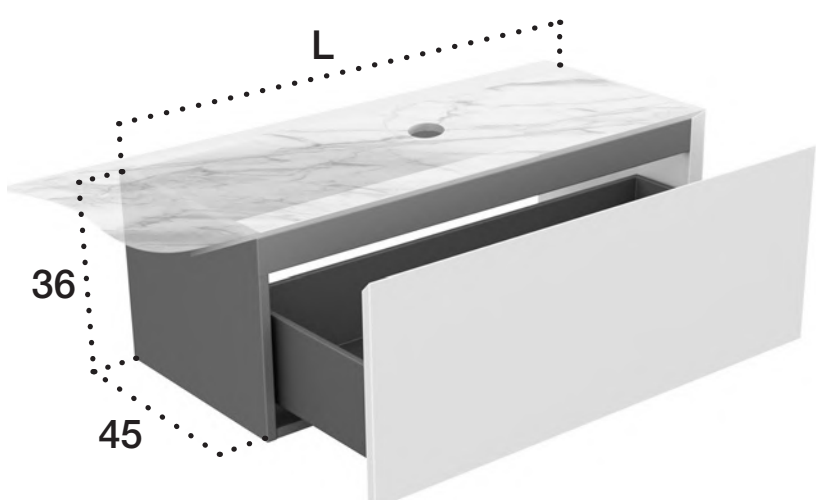

| Art.           | P  | L   | H  |
|----------------|----|-----|----|
| <b>N8P 60</b>  | 45 | 60  | 36 |
| <b>N8P 80</b>  |    | 80  | 36 |
| <b>N8P 100</b> |    | 100 | 36 |
| <b>N8P 120</b> |    | 120 | 36 |
| <b>N8P 140</b> |    | 140 | 36 |
| <b>N8P 160</b> |    | 160 | 36 |

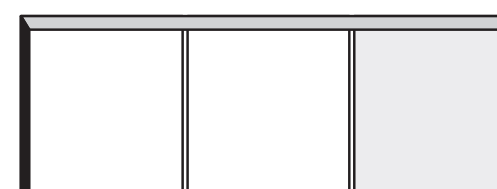

| Cat. 1       | Cat. 2       | Cat. 3       |
|--------------|--------------|--------------|
| <b>1.610</b> | <b>1.790</b> | <b>1.730</b> |
| <b>1.840</b> | <b>2.020</b> | <b>1.980</b> |
| <b>2.070</b> | <b>2.280</b> | <b>2.220</b> |
| <b>2.290</b> | <b>2.510</b> | <b>2.480</b> |
| <b>2.530</b> | <b>2.770</b> | <b>2.690</b> |
| <b>2.780</b> | <b>3.000</b> | <b>2.920</b> |

**BASE COMPLETA, 1 CASSETTO CON TOP IN MARMO 1** | Complete unit with 1 drawer and marble 1 top | Unterschrank 1 Schublade und Platte aus Marmor 1 | Base avec 1 tiroir et top en marbre 1 |Modulo con 1 cajon y encimera en marmol 1

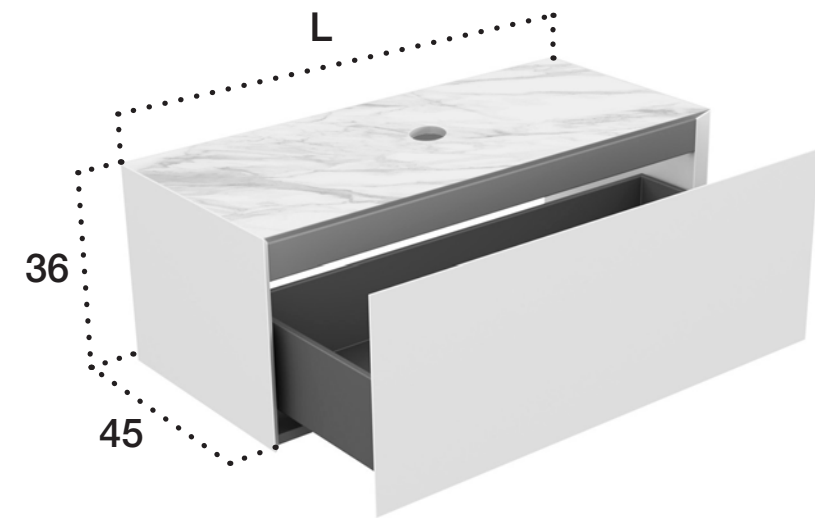

| Art.           | P  | L   | H  |
|----------------|----|-----|----|
| <b>N8T 60</b>  | 45 | 60  | 36 |
| <b>N8T 80</b>  |    | 80  | 36 |
| <b>N8T 100</b> |    | 100 | 36 |
| <b>N8T 120</b> |    | 120 | 36 |
| <b>N8T 140</b> |    | 140 | 36 |
| <b>N8T 160</b> |    | 160 | 36 |

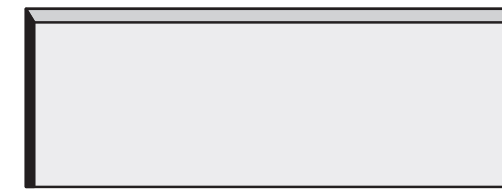

| Cat. 1       | Cat. 2       | Cat. 3       |
|--------------|--------------|--------------|
| <b>1.700</b> | <b>1.870</b> | <b>1.860</b> |
| <b>1.920</b> | <b>2.110</b> | <b>2.100</b> |
| <b>2.160</b> | <b>2.370</b> | <b>2.350</b> |
| <b>2.380</b> | <b>2.600</b> | <b>2.610</b> |
| <b>2.610</b> | <b>2.860</b> | <b>2.820</b> |
| <b>2.860</b> | <b>3.090</b> | <b>3.050</b> |

**BASE COMPONENTE LATERALE SX, 1 CASSETTO CON TOP IN MARMO 2** | Left hand modular unit with 1 drawer and marble 2 top | Modulare Basis linke Version, 1 Schublade und Platte aus Marmor 2 | Base modulaire gauche avec 1 tiroir et top en marbre 2 | Modulo componibile izquierdo con 1 cajon y encimera de marmol 2

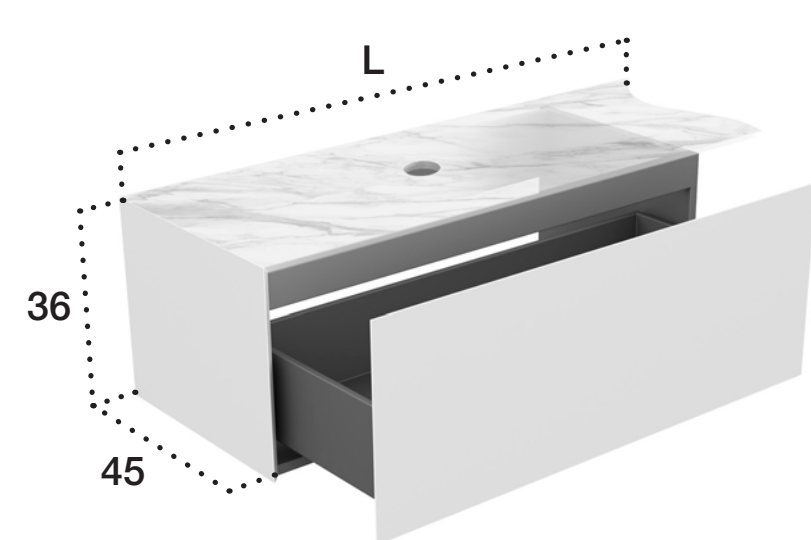

| Art.           | P  | L   | H  |
|----------------|----|-----|----|
| <b>N82</b> 60  | 45 | 60  | 36 |
| <b>N82</b> 80  |    | 80  | 36 |
| <b>N82</b> 100 |    | 100 | 36 |
| <b>N82</b> 120 |    | 120 | 36 |
| <b>N82</b> 140 |    | 140 | 36 |
| <b>N82</b> 160 |    | 160 | 36 |



| Cat. 1       | Cat. 2       | Cat. 3       |
|--------------|--------------|--------------|
| <b>2.220</b> | <b>2.390</b> | <b>2.340</b> |
| <b>2.650</b> | <b>2.830</b> | <b>2.780</b> |
| <b>3.080</b> | <b>3.290</b> | <b>3.230</b> |
| <b>3.500</b> | <b>3.720</b> | <b>3.690</b> |
| <b>3.940</b> | <b>4.180</b> | <b>4.100</b> |
| <b>4.390</b> | <b>4.620</b> | <b>4.540</b> |

**BASE COMPONENTE CENTRALE, 1 CASSETTO CON TOP IN MARMO 2** | Central modular unit with 1 drawer and top in marble 2 | Modulare Basis mittige Version, 1 Schublade und Platte aus Marmor 2 | Base modulaire centrale avec 1 tiroir et top en marbre 2 | Modulo componibile central con 1 cajon y encimera de marmol 2

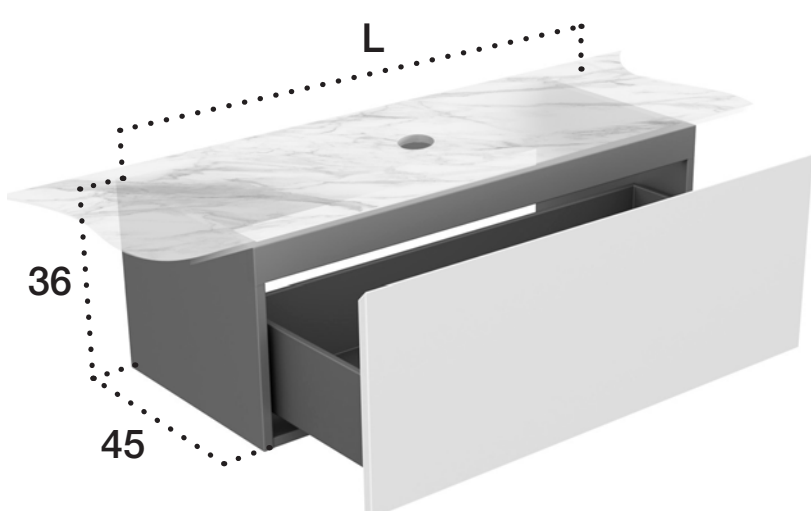

| Art.           | P  | L   | H  |
|----------------|----|-----|----|
| <b>N84</b> 60  | 45 | 60  | 36 |
| <b>N84</b> 80  |    | 80  | 36 |
| <b>N84</b> 100 |    | 100 | 36 |
| <b>N84</b> 120 |    | 120 | 36 |
| <b>N84</b> 140 |    | 140 | 36 |
| <b>N84</b> 160 |    | 160 | 36 |



| Cat. 1       | Cat. 2       | Cat. 3       |
|--------------|--------------|--------------|
| <b>2.110</b> | <b>2.250</b> | <b>2.180</b> |
| <b>2.540</b> | <b>2.690</b> | <b>2.630</b> |
| <b>2.970</b> | <b>3.140</b> | <b>3.080</b> |
| <b>3.390</b> | <b>3.580</b> | <b>3.530</b> |
| <b>3.830</b> | <b>4.040</b> | <b>3.940</b> |
| <b>4.280</b> | <b>4.480</b> | <b>4.380</b> |

**BASE COMPONENTE LATERALE DX, 1 CASSETTO CON TOP IN MARMO 2** | Right hand modular unit with 1 drawer and marble 2 top | Modulare Basis rechte Version, 1 Schublade und Platte aus Marmor 2 | Base modulaire droite avec 1 tiroir et top en marbre 2 | Modulo componibile derecho con 1 cajon y encimera en marmol 2

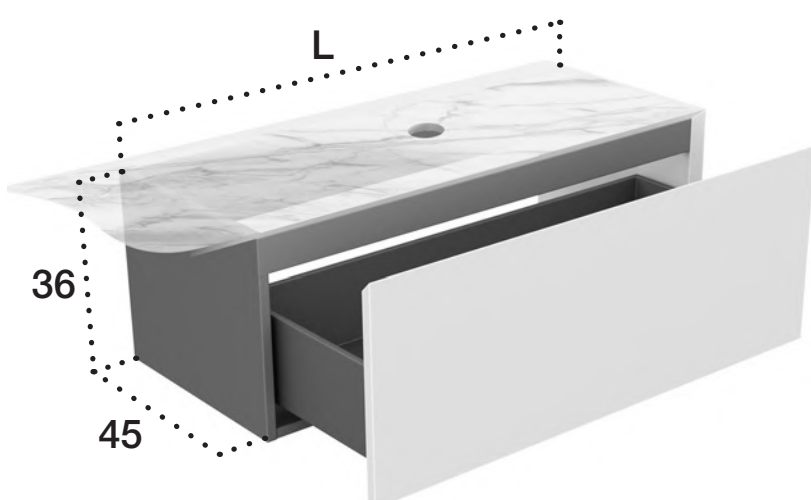

| Art.           | P  | L   | H  |
|----------------|----|-----|----|
| <b>N86</b> 60  | 45 | 60  | 36 |
| <b>N86</b> 80  |    | 80  | 36 |
| <b>N86</b> 100 |    | 100 | 36 |
| <b>N86</b> 120 |    | 120 | 36 |
| <b>N86</b> 140 |    | 140 | 36 |
| <b>N86</b> 160 |    | 160 | 36 |

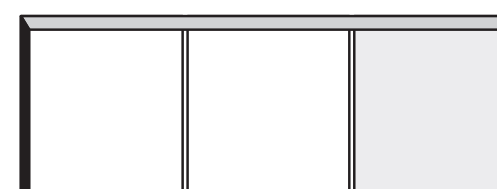

| Cat. 1       | Cat. 2       | Cat. 3       |
|--------------|--------------|--------------|
| <b>2.220</b> | <b>2.390</b> | <b>2.340</b> |
| <b>2.650</b> | <b>2.830</b> | <b>2.780</b> |
| <b>3.080</b> | <b>3.290</b> | <b>3.230</b> |
| <b>3.500</b> | <b>3.720</b> | <b>3.690</b> |
| <b>3.940</b> | <b>4.180</b> | <b>4.100</b> |
| <b>4.390</b> | <b>4.620</b> | <b>4.540</b> |



**BASE COMPLETA, 1 CASSETTO CON TOP IN MARMO 2** | Complete unit with 1 drawer and marble 2 top | Unterschrank 1 Schublade und Platte aus Marmor 2 | Base avec 1 tiroir et top en marbre 2 |Modulo con 1 cajon y encimera en marmol 2

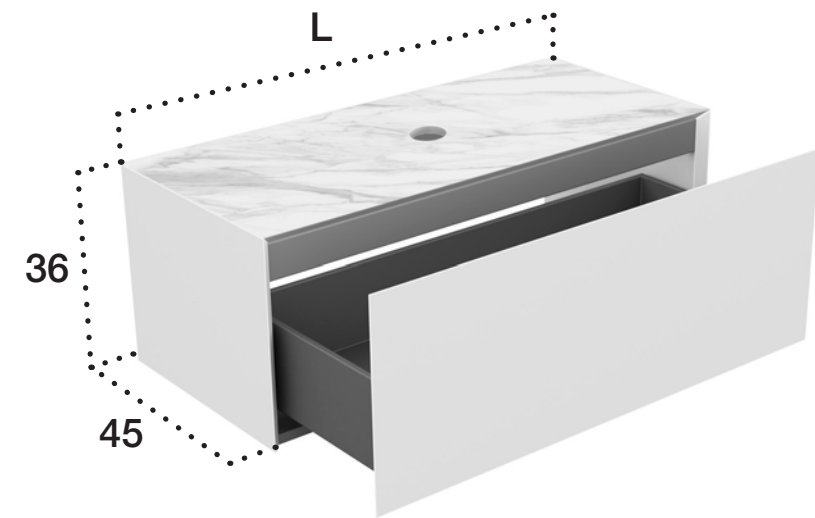

| Art.           | P  | L   | H  |
|----------------|----|-----|----|
| <b>N87</b> 60  | 45 | 60  | 36 |
| <b>N87</b> 80  |    | 80  | 36 |
| <b>N87</b> 100 |    | 100 | 36 |
| <b>N87</b> 120 |    | 120 | 36 |
| <b>N87</b> 140 |    | 140 | 36 |
| <b>N87</b> 160 |    | 160 | 36 |

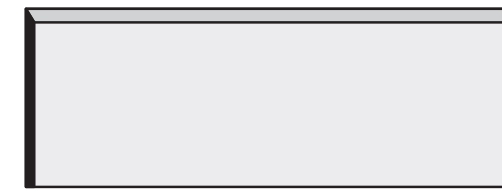

| Cat. 1       | Cat. 2       | Cat. 3       |
|--------------|--------------|--------------|
| <b>2.300</b> | <b>2.480</b> | <b>2.470</b> |
| <b>2.730</b> | <b>2.920</b> | <b>2.910</b> |
| <b>3.170</b> | <b>3.370</b> | <b>3.360</b> |
| <b>3.590</b> | <b>3.810</b> | <b>3.820</b> |
| <b>4.030</b> | <b>4.270</b> | <b>4.230</b> |
| <b>4.480</b> | <b>4.700</b> | <b>4.660</b> |

TOP LEGNO 10 CM AUTOPORTANTE | Self-supporting wooden top height 10 cm | Topplatte aus Holz H 10 cm, Selbsttragend | Plan autoportant 10 cm en bois | Encimera de madera 10 cm autoportante

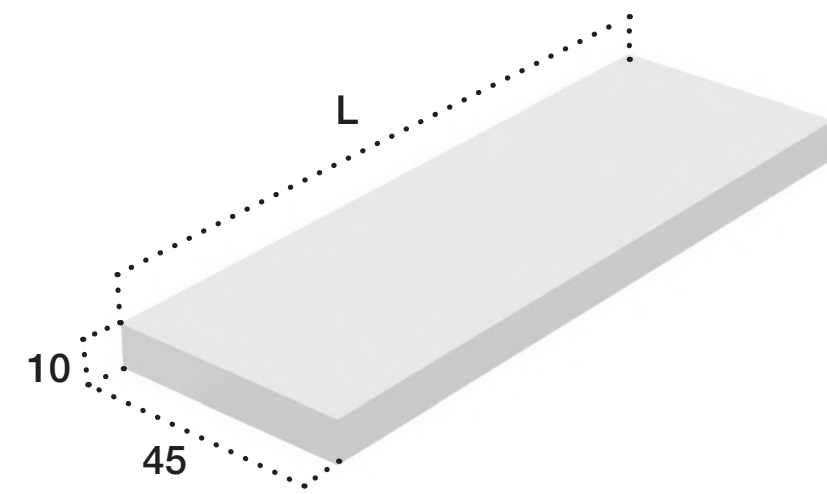

| Art.           | P  | L   | H  | Cat. 1 | Cat. 2 | Cat. 3 |
|----------------|----|-----|----|--------|--------|--------|
| <b>N91</b> 140 | 45 | 140 | 10 | 840    | 1.110  | 1.030  |
| <b>N91</b> 160 |    | 160 | 10 | 930    | 1.220  | 1.130  |
| <b>N91</b> 180 |    | 180 | 10 | 1.010  | 1.330  | 1.230  |
| <b>N91</b> 200 |    | 200 | 10 | 1.090  | 1.440  | 1.330  |
| <b>N91</b> 220 |    | 220 | 10 | 1.170  | 1.550  | 1.440  |
| <b>N91</b> 240 |    | 240 | 10 | 1.250  | 1.660  | 1.540  |
| <b>N91</b> 260 |    | 260 | 10 | 1.330  | 1.780  | 1.640  |
| <b>N91</b> 280 |    | 280 | 10 | 1.420  | 1.890  | 1.750  |
| <b>N91</b> 300 |    | 300 | 10 | 1.490  | 2.000  | 1.850  |

| Art.       |   | Prezzo |
|------------|---|--------|
| <b>D4X</b> | <b>Foro per lavabo extra listino</b> / Hole for basin not included in the price list / Bohrung für Waschbecken nicht im Listenpreis inbegriffen / <i>Trou pour lavabo extra tarif</i> / Orificio para lavabo no incluido en la lista de precios | 113    |
| <b>D43</b> | <b>Forature per lavabi Falper</b> / Openings for Falper basins / Bohrungen für Falper Waschbecken / <i>Ouvertures pour lavabos Falper</i> / Orificios para lavabos Falper   | 82     |

**IMPORTANTE: le staffe per il supporto del top sono comprese** / **Important: top supporting brackets are included.** / Wichtig: Die Abstützbügel für das Top sind inbegriffen / *Important: les pattes de support sont comprises* / *Importante: los soportes para sujetar el top están incluido*

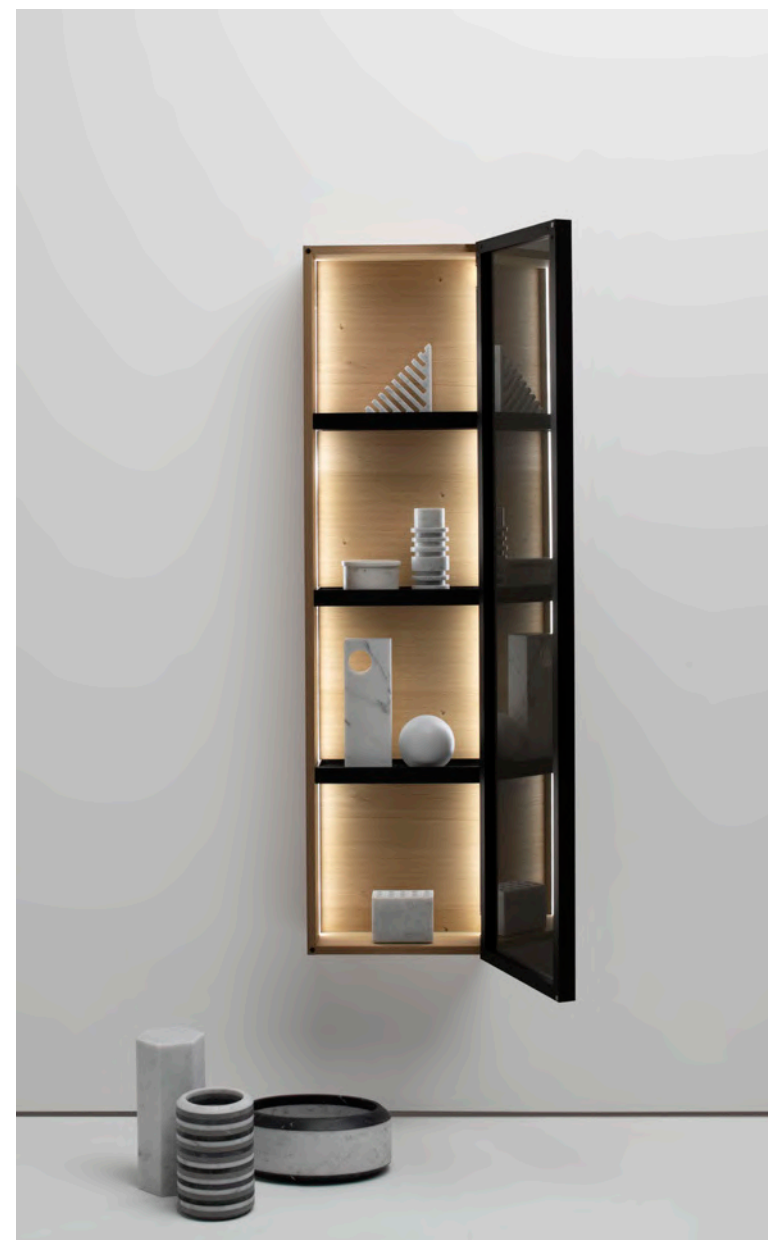

# BUTLER SISTEMA GUARDAROBA PER BAGNO | *Butler bathroom wardrobe system*

Butler Gardarobesystem für Badezimmer | Butler système garde-robe pour salle de bain | Butler sistema vestuario para baño

**FINITURE** | Finishes | Oberfläche | Finitions | Acabados







## Cat. 1 / Cat. 3

**LACCATI OPACHI E LUCIDI** | Matt and glossy painted | Matte und glänzende Lackierung | Lacqué opaque et brillant | Laqueados opacos y brillantes

|   |  |   |  |   |   |  |  |   |   |   |  |
|---|--|---|--|---|---|--|--|---|---|---|--|
|  |                             |  |                                |                                |  |                               |             |  |  |                  |  |
| <b>B0 / BL</b><br><b>Bianco</b><br>White<br>Weiß<br>Blanc<br>Blanco               | <b>GP / GL</b><br><b>Grigio Pavillon</b><br>Pavillon grey<br>Pavillon Grau<br>Gris Pavillon<br>Gris Pavillon | <b>PI / PA</b><br><b>Pioggia</b><br>Rain<br>Regen<br>Pluie<br>Iluvia              | <b>GL / GM</b><br><b>Grigio Londra</b><br>London grey<br>London Grau<br>Gris Londres<br>Gris Londres             | <b>EY / EZ</b><br><b>Grigio Exclusive</b><br>Exclusive grey<br>Exclusive Grau<br>Gris Exclusive<br>Gris Exclusive | <b>GF / GT</b><br><b>Grafite</b><br>Graphite<br>Graphit<br>Graphite<br>Grafito      | <b>N2 / N1</b><br><b>Nero</b><br>Black<br>Schwarz<br>Noir<br>Negro   | <b>G5 / G6</b><br><b>Grigio Bromo</b><br>Bromo grey<br>Bromo Grau<br>Gris Bromo<br>Gris Bromo  | <b>FA / FN</b><br><b>Fango</b><br>Mud<br>Schlamm<br>Boue<br>Barro                   | <b>VI / VN</b><br><b>Visone</b><br>Mink<br>Nerz<br>Vison<br>Vison                   | <b>AZ / A1</b><br><b>Azzurro polvere</b><br>Blue powder<br>Blau Puder<br>Bleu poudre<br>Azul pálido |  |
|  |                             |  |                                |                                |  |                               |             |  |  |   |  |
| <b>CA / CP</b><br><b>Canapa</b><br>Hemp<br>Hanf<br>Chanvre<br>Cáñamo              | <b>S2 / S1</b><br><b>Sabbia</b><br>Sand<br>Sand<br>Sable<br>Arena  | <b>C2 / C1</b><br><b>Creta</b><br>Clay<br>Ton<br>Crête<br>Creta                   | <b>C7 / C8</b><br><b>Castoro Ottawa</b><br>Ottawa Beaver<br>Biber-Farbe Ottawa<br>Castor Ottawa<br>Castor Ottawa | <b>CD / CL</b><br><b>Argilla</b><br>Argilla<br>Argilla<br>Argilla<br>Argilla                                      | <b>FE / FR</b><br><b>Ferro</b><br>Iron<br>Eisen<br>Fer<br>Hierro                    | <b>V1 / V2</b><br><b>Verde Comodoro</b><br>Green Commodore<br>Commodore Grün<br>Vert Commodore<br>Verde Comodoro | <b>V7 / V8</b><br><b>Verde Agave</b><br>Agave Green<br>Agave Grau<br>Vert Agave<br>Verde Agave | <b>AV / AI</b><br><b>Avio</b><br>Aviation<br>Luftfahrt<br>Aviation<br>Aviación      | <b>B7 / B8</b><br><b>Blu Fes</b><br>Fes blue<br>Blau Fes<br>Bleu Fes<br>Azul Fes    |   |  |

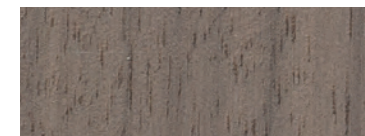
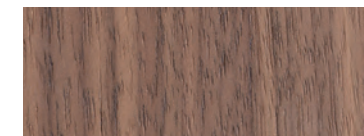
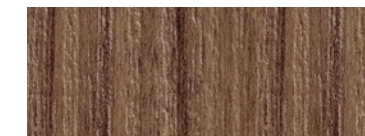
## Cat. 2

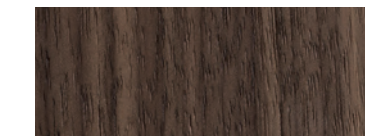
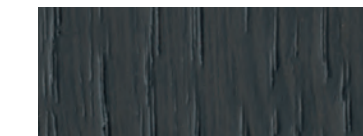
**LEGNI** | Woods | Holz | Bois | Maderas

|   |  |  |  |   |  |   |   |  |   |
|---|--|--|--|---|--|---|---|--|---|
|  |                             |   |                          |                      |                               |                    |            |     |  |
| <b>R4</b><br><b>Rovere</b><br>Oak<br>Eiche<br>Rouvre<br>Roble                       | <b>RP</b><br><b>Rovere sbiancato</b><br>Bleached oak<br>Gebleichte Eiche<br>Rouvre blanchi<br>Roble blanqueado | <b>RK</b><br><b>Rovere Solid Skin</b><br>Solid Skin oak<br>Eiche "Solid Skin"<br>Rouvre "Solid Skin"<br>Roble "Solid Skin" | <b>CG</b><br><b>Canaletto grigio</b><br>Grey Canaletto<br>Canaletto grau<br>Canaletto gris<br>Canaletto gris | <b>N8</b><br><b>Noce naturale</b><br>Natural walnut<br>Nussbaum Natur<br>Noyer naturel<br>Nogal naturales | <b>NC</b><br><b>Noce Canaletto</b><br>Canaletto walnut<br>Nussbaum Canaletto<br>Noyer Canaletto<br>Nogal Canaletto | <b>N6</b><br><b>Noce bruciato</b><br>Walnut burned<br>Nussbaum gebrannt<br>Noyer brûlé<br>Nogal quemado | <b>NW</b><br><b>Noce Brown</b><br>Walnut Brown<br>Nussbaum braun<br>Noyer Foncé<br>Nogal marrón | <b>RG</b><br><b>Rovere grigio</b><br>Grey oak<br>Eiche grau<br>Rouvre gris<br>Roble gris | <b>W4</b><br><b>Wengé</b><br>Wengé<br>Wengé<br>Wengé<br>Wengué                        |

**ANTA** | Door | Tür | Porte | Puerta

|  |   |
|--|---|
|   |                            |
| <b>Alluminio nero opaco</b><br>Matt black aluminum<br>Mattschwarzes Aluminium<br>Aluminium noir mat<br>Aluminio negro mate | <b>Vetro dark grey</b><br>Dark grey mirror<br>Dunkelgrauer Spiegel<br>Miroir gris foncé<br>Espejo gris oscuro |

BUTLER SISTEMA GUARDAROBA PER BAGNO | *Butler bathroom wardrobe system*  
 Butler Gardarobesystem für Badezimmer | Butler système garde-robe pour salle de bain | Butler sistema vestuario para baño

**COLONNA 1 ANTA E RIPIANI IN VETRO** | Column with 1 door and glass shelves | Hochschrank mit Tür und Glasablagen | Colonne 1 porte et étagères en verre | Columna con puerta y repisas en vidrio



Versione DX | Right version

| Art.                   | P  | L  | H   |
|------------------------|----|----|-----|
| <b>FTA DX • FTB SX</b> | 20 | 40 | 150 |

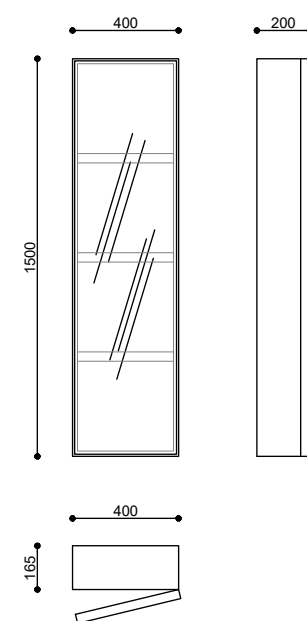

Versione DX | Right version

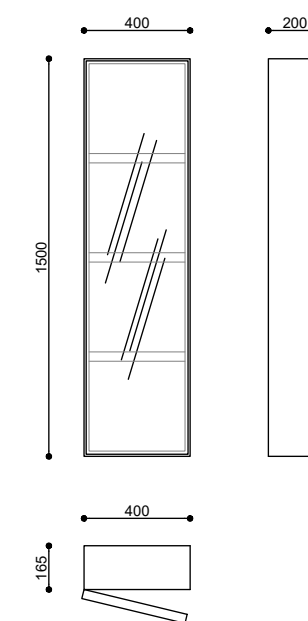

Versione SX | Left version

| Cat. 1       | Cat. 2       | Cat. 3       |
|--------------|--------------|--------------|
| <b>2.190</b> | <b>2.390</b> | <b>2.290</b> |

**COLONNA 2 ANTE E RIPIANI IN VETRO** | Column with 2 doors and glass shelves | Hochschrank mit 2 Türen und Glasablagen | Colonne 2 portes et étagères en verre | Columna con 2 puertas y repisas en vidrio



Novità / News 2021.1

| Art.       | P  | L  | H   |
|------------|----|----|-----|
| <b>FTC</b> | 20 | 80 | 150 |

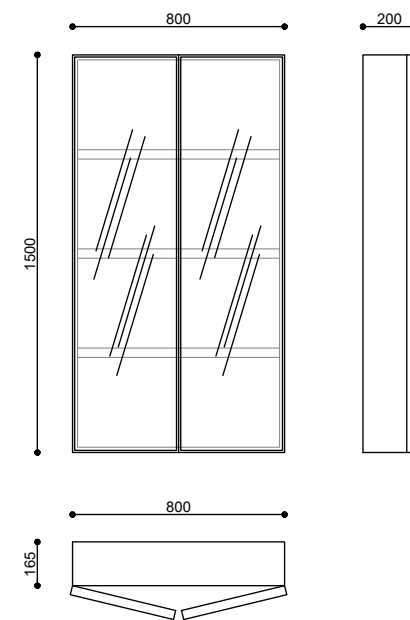

| Cat. 1       | Cat. 2       | Cat. 3       |
|--------------|--------------|--------------|
| <b>3.290</b> | <b>3.490</b> | <b>3.390</b> |

## BUTLER SISTEMA GUARDAROBA PER BAGNO | *Butler bathroom wardrobe system*

Butler Gardarobesystem für Badezimmer | Butler système garde-robe pour salle de bain | Butler sistema vestuario para baño

**COLONNA 1 ANTA E RIPIANI IN VETRO CON CASSETTI INTERNI** | Column with door, glass shelves and internal drawers | Hochschrank mit Tür, Glasablagen und Innenschubladen | Colonne 1 porte et étagères en verre avec tiroirs intérieurs  
Columna con puerta, repisas en vidrio y cajones interiores



Versione DX | Right version

| Art.                   | P  | L  | H   |
|------------------------|----|----|-----|
| <b>FTD DX • FTE SX</b> | 35 | 40 | 150 |

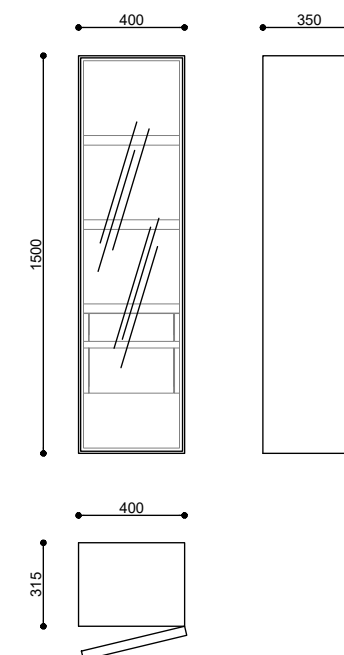

Versione DX | Right version

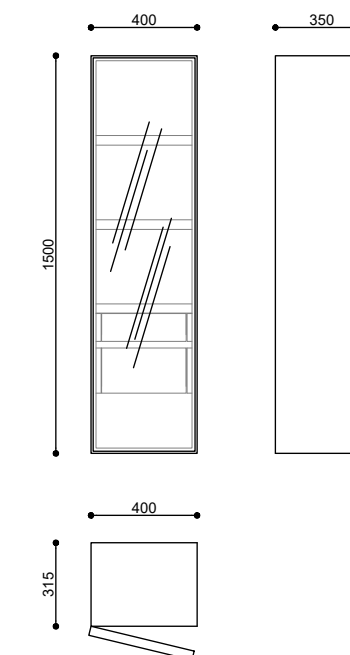

Versione SX | Left version

| Cat. 1       | Cat. 2       | Cat. 3       |
|--------------|--------------|--------------|
| <b>3.290</b> | <b>3.490</b> | <b>3.390</b> |

**COLONNA 2 ANTE E RIPIANI IN VETRO CON CASSETTI INTERNI** | Column with 2 doors, glass shelves and internal drawers | Hochschrank mit 2 Türen, Glasablagen und Innenschubladen | Colonne 2 portes et étagères en verre avec tiroirs intérieurs  
Columna con 2 puertas, repisas en vidrio y cajones interiores

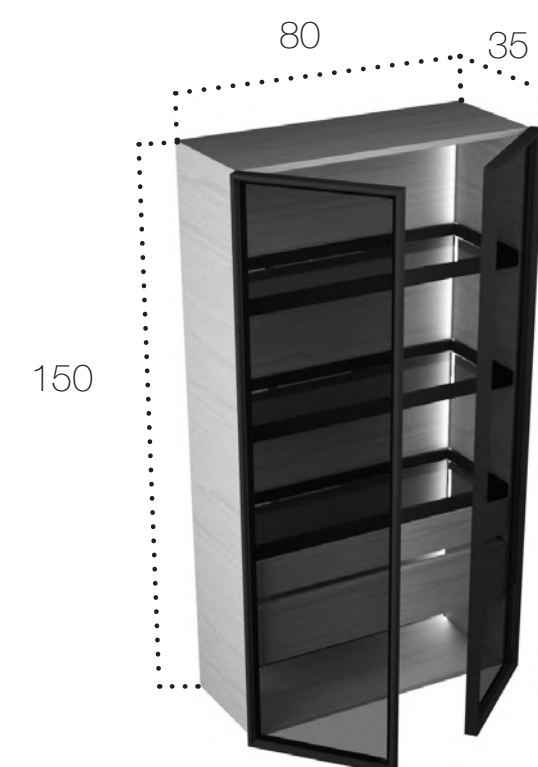

| Art.       | P  | L  | H   |
|------------|----|----|-----|
| <b>FTF</b> | 35 | 80 | 150 |

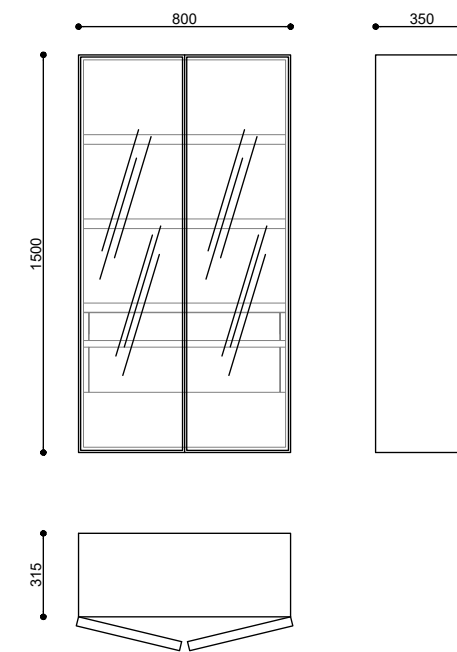

| Cat. 1       | Cat. 2       | Cat. 3       |
|--------------|--------------|--------------|
| <b>4.980</b> | <b>5.290</b> | <b>5.190</b> |

# BUTLER SISTEMA GUARDAROBA PER BAGNO | *Butler bathroom wardrobe system*

Butler Gardarobesystem für Badezimmer | Butler système garde-robe pour salle de bain | Butler sistema vestuario para baño

**COLONNA 2 ANTE E RIPIANI IN VETRO CON CASSETTI INTERNI** | Column with 2 doors, glass shelves and internal drawers | Hochschrank mit 2 Türen, Glasablagen und Innenschubladen | Colonne 2 portes et étagères en verre avec tiroirs intérieurs  
Columna con 2 puertas, repisas en vidrio y cajones interiores

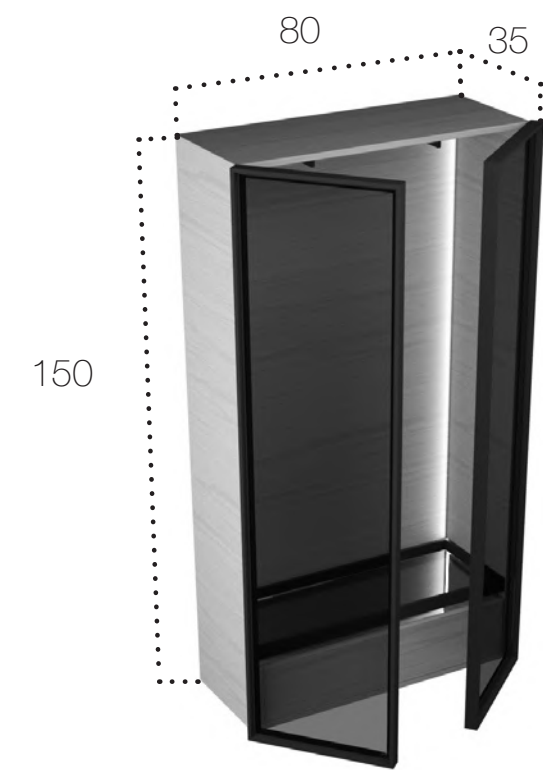

Art.

**FTG**

P L H

35 80 150

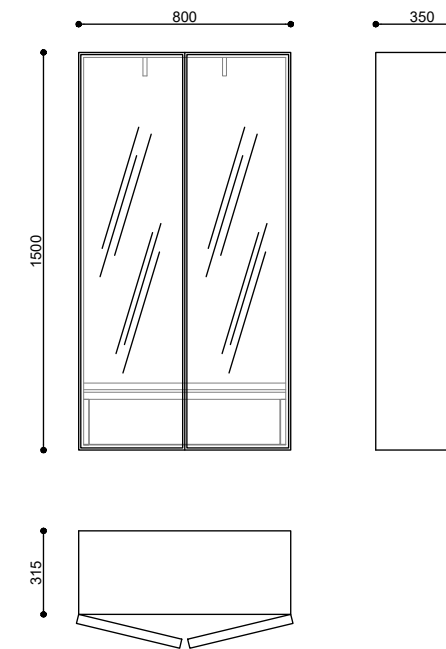

**Cat. 1 Cat.2 Cat.3**

**4.250 4.490 4.390**





## DIVISORI PER CASSETTI | *Drawer dividers*

Schubladeneinteiler | Séparateurs pour tiroirs | Separadores para cajones

**FINITURE** | Finishes | Oberfläche | Finitions | Acabados

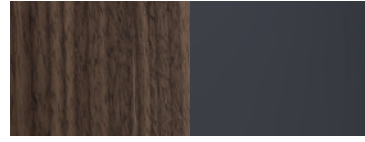

**Noce Brown / Grigio**

Walnut Brown / Grey  
Nussbaum Braun / Grau  
Noyer Foncé / Gris  
Nogal marrón / Gris



**Rovere / Grigio**

Oak / Grey  
Eiche / Grau  
Rouvre / Gris  
Roble / Gris

## DIVISORI PER CASSETTI | *Drawer dividers*

Schubladeneinteiler | Séparateurs pour tiroirs | Separadores para cajones

### CONTENITORI PER CASSETTI SISTEMA BUTLER | Drawer containers for Butler system | Behälter für Schubladen für Butlersystem | Conteneurs pour tiroirs de la colonne Butler | Contenedores para cajones para el sistema Butler



Art. P L H

|            |    |    |   |                 |
|------------|----|----|---|-----------------|
| <b>FT1</b> | 25 | 15 | 5 | Vassoio         |
| <b>FT2</b> | 25 | 15 | 5 | Porta oggetti   |
| <b>FT3</b> | 25 | 15 | 5 | Porta orecchini |
| <b>FT4</b> | 25 | 15 | 5 | Porta orologi   |
| <b>FT5</b> | 25 | 15 | 5 | Porta anelli    |

**Noce Brown / Grigio**

Brown Walnut / Grey

**Rovere / Grigio**

Oak / Grey

**149**

**149**

**168**

**168**

**210**

**210**

**258**

**258**

**258**

**258**

#### Vassoio

Tray  
Tablett  
Plateau  
Bandeja

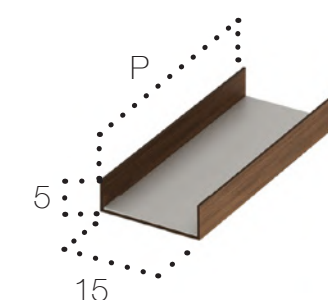

#### Porta oggetti

Port objects  
Handschuhfach  
Porte-objet  
Guantera

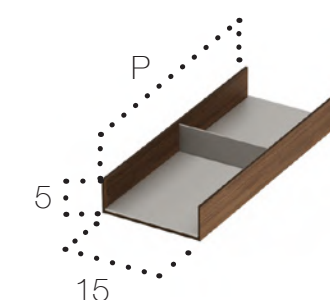

#### Porta orecchini

Earrings storage  
Behälter für Ohringe  
Porte-boucles d'oreilles  
Contenedor para pendientes

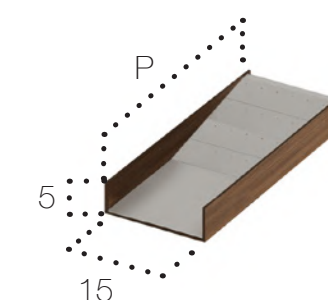

#### Porta orologi

Watch storage  
Behälter für Uhren  
Porte-montre  
Contenedor para relojes

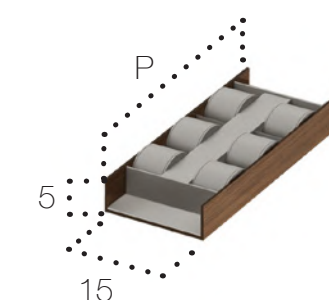

#### Porta anelli

Ring storage  
Behälter für Ringe  
Porte-bague  
Contenedor para anillos

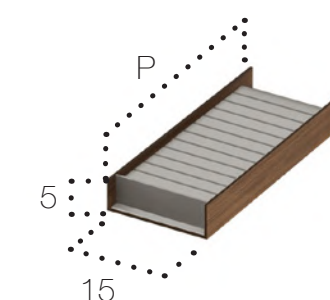

**Accessori in laminato compatto di soli 4 mm di spessore impiallacciato noce Canaletto o Rovere. Equipaggiato con una vasta gamma di divisioni interne fatte a mano, realizzate in un'innovativa simil pelle tattile.**

Accessories in compact laminate just 4 mm thick with Canaletto walnut veneer or Oak. Equipped with a wide range of handmade internal divisions, made in an innovative tactile leatherette.

Zubehör aus kompaktem Laminat mit einer Dicke von nur 4 mm und Canaletto-Walnussfurnier oder Eiche. Ausgestattet mit einer großen Auswahl an handgefertigten Innenabteilungen aus innovativem taktilem Kunstleder.

Accessoires en stratifié compact de seulement 4mm d'épaisseur avec placage de Noyer Canaletto ou Rouvre. Équipé d'une large gamme de divisions internes faites à la main, fabriquées dans un innovant similicuir tactile.

Accesorios en laminado compacto de tan solo 4 mm de espesor con chapa de nogal Canaletto o Roble. Equipado con una amplia gama de divisiones internas hechas a mano, realizadas en una innovadora piel sintética táctil.

# DIVISORI PER CASSETTI | *Drawer dividers*

Schubladeneinteiler | Séparateurs pour tiroirs | Separadores para cajones

## CONTENITORI PER CASSETTI SISTEMA BUTLER | Drawer containers for Butler system | Behälter für Schubladen für Butlersystem | Conteneurs pour tiroirs système Butler | Contenedores para cajones para el sistema Butler



| Art.        | P  | L  | H |                 | Noce Brown / Grigio |  | Rovere / Grigio |  |
|-------------|----|----|---|-----------------|---------------------|--|-----------------|--|
|             |    |    |   |                 | Brown Walnut / Grey |  | Oak / Grey      |  |
| <b>FX1</b>  | 32 | 15 | 5 | Vassoio         | <b>149</b>          |  | <b>149</b>      |  |
| <b>FX2</b>  | 32 | 15 | 5 | Porta oggetti   | <b>168</b>          |  | <b>168</b>      |  |
| <b>FX3</b>  | 32 | 15 | 5 | Porta orecchini | <b>210</b>          |  | <b>210</b>      |  |
| <b>FX4</b>  | 32 | 15 | 5 | Porta orologi   | <b>258</b>          |  | <b>258</b>      |  |
| <b>FX5</b>  | 32 | 15 | 5 | Porta anelli    | <b>258</b>          |  | <b>258</b>      |  |
| <b>FX 6</b> | 32 | 15 | 5 | Porta trucchi   | <b>258</b>          |  | <b>258</b>      |  |
| <b>FY1</b>  | 37 | 15 | 5 | Vassoio         | <b>149</b>          |  | <b>149</b>      |  |
| <b>FY2</b>  | 37 | 15 | 5 | Porta oggetti   | <b>168</b>          |  | <b>168</b>      |  |
| <b>FY3</b>  | 37 | 15 | 5 | Porta orecchini | <b>210</b>          |  | <b>210</b>      |  |
| <b>FY4</b>  | 37 | 15 | 5 | Porta orologi   | <b>258</b>          |  | <b>258</b>      |  |
| <b>FY5</b>  | 37 | 15 | 5 | Porta anelli    | <b>258</b>          |  | <b>258</b>      |  |
| <b>FY6</b>  | 37 | 15 | 5 | Porta trucchi   | <b>258</b>          |  | <b>258</b>      |  |

**Vassoio**  
Tray  
Tablett  
Plateau  
Bandeja

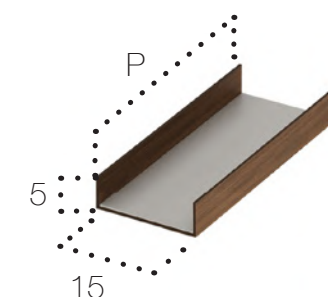

**Porta oggetti**  
Port objects  
Handschuhfach  
Porte-objet  
Guantera

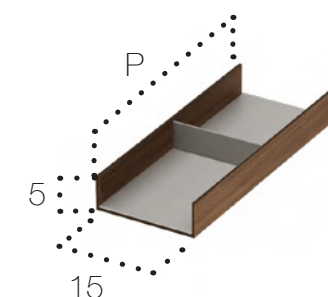

**Porta orecchini**  
Earrings storage  
Behälter für Ohrhinge  
Porte-boucles d'oreilles  
Contenedor para pendientes

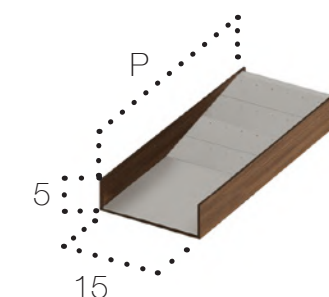

**Porta orologi**  
Watch storage  
Behälter für Uhren  
Porte-montre  
Contenedor para relojes

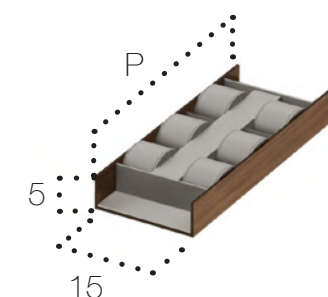

**Porta anelli**  
Ring storage  
Behälter für Ringe  
Porte-bague  
Contenedor para anillos

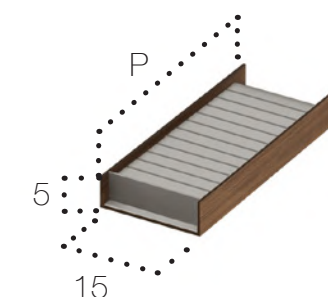

**Porta trucchi**  
Make-up storage  
Behälter für Make-up  
Porte-Maquillage  
Contenedor para maquillaje

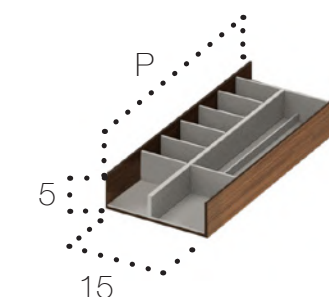

**Accessori in laminato compatto di soli 4 mm di spessore impiallacciato noce Canaletto o Rovere. Equipaggiato con una vasta gamma di divisioni interne fatte a mano, realizzate in un'innovativa simil pelle tattile.**

Accessories in compact laminate just 4 mm thick with Canaletto walnut veneer or Oak. Equipped with a wide range of handmade internal divisions, made in an innovative tactile leatherette.

Zubehör aus kompaktem Laminat mit einer Dicke von nur 4 mm und Canaletto-Walnutssplam oder Eiche. Ausgestattet mit einer großen Auswahl an handgefertigten Innenabteilungen aus innovativem taktilem Kunstleder.

Accessoires en stratifié compact de seulement 4mm d'épaisseur avec placage de Noyer Canaletto ou Rouvre. Équipé d'une large gamme de divisions internes faites à la main, fabriquées dans un innovant similicuir tactile.

Accesorios en laminado compacto de tan solo 4 mm de espesor con chapa de nogal Canaletto o Roble. Equipado con una amplia gama de divisiones internas hechas a mano, realizadas en una innovadora piel sintética táctil.

**P 32 | Compatibile con mobili profondità 45 cm** | Compatible with units depth 45 cm | Kompatibel mit Möbel in Tiefe 45 | Compatible avec meubles avec profondeur 45 cm  
Compatibles con mueble de profundidad 45 cm

**P 37 | Compatibile con mobili profondità 55 cm** | Compatible with units depth 55 cm | Kompatibel mit Möbel in Tiefe 55 | Compatible avec meubles avec profondeur 55 cm  
Compatibles con mueble de profundidad 55 cm

**Non compatibili con collezione 7.0** | Not Compatible with 7.0 collection | Nicht kompatibel mit Kollektion 7.0 | Non compatibles avec la collection 7.0 | No compatibles con la colección 7.0

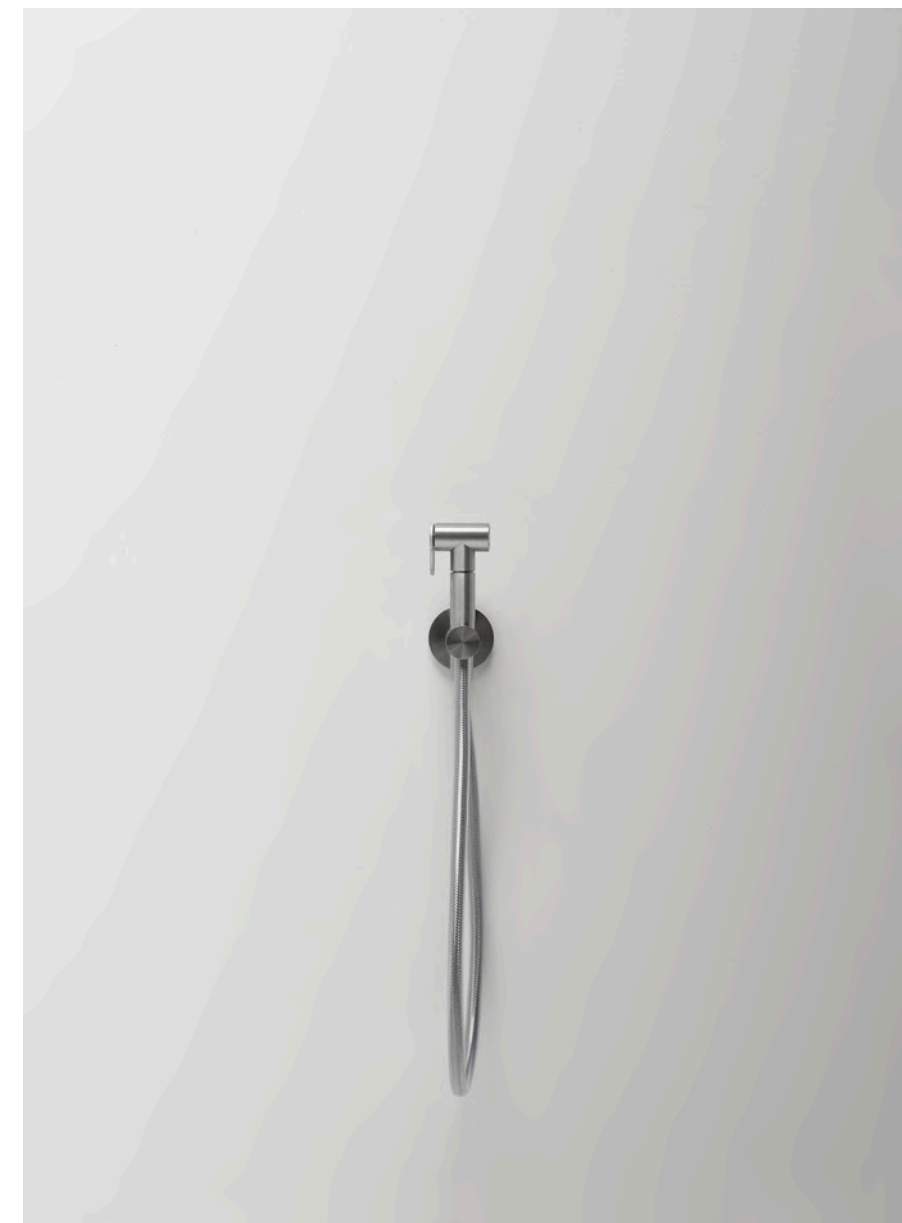
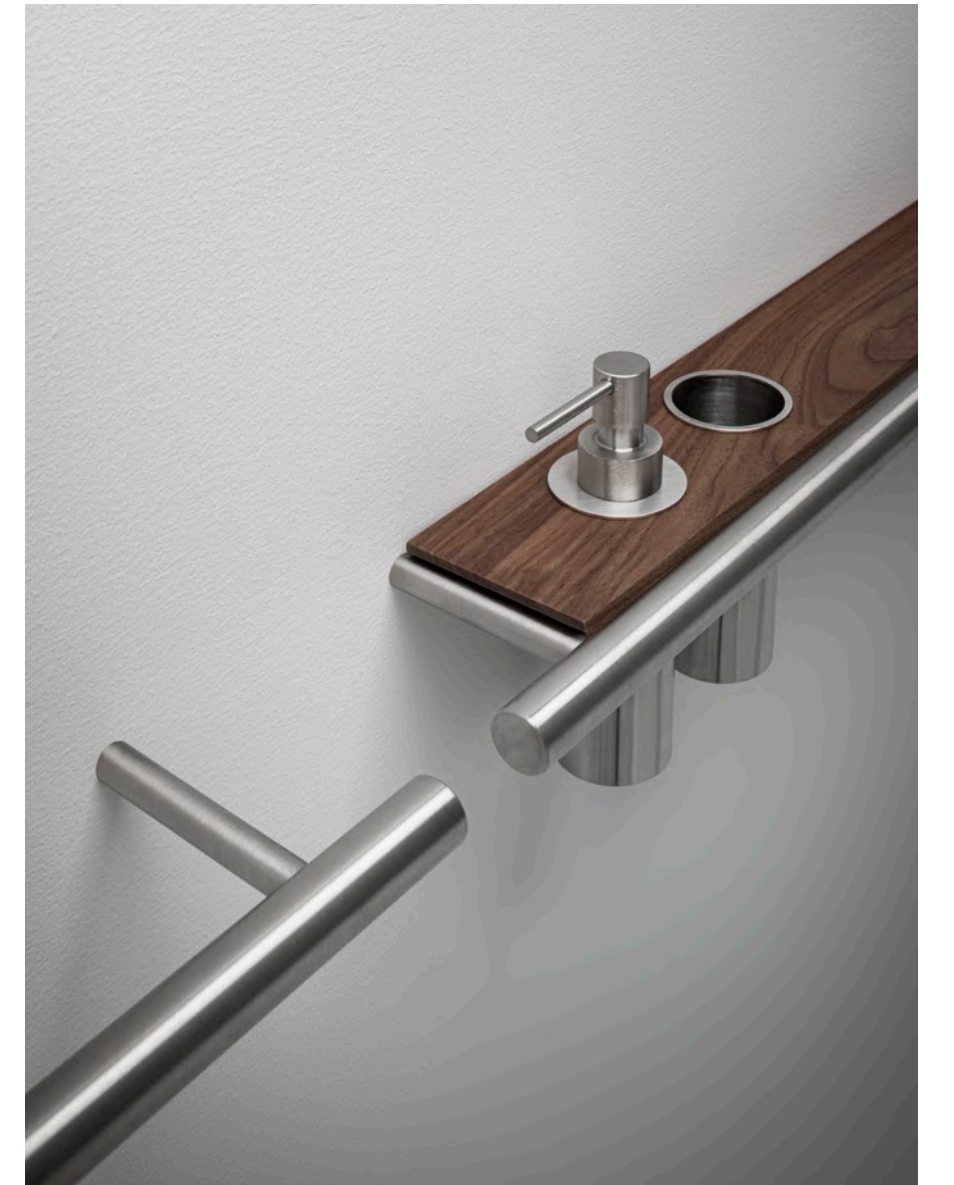
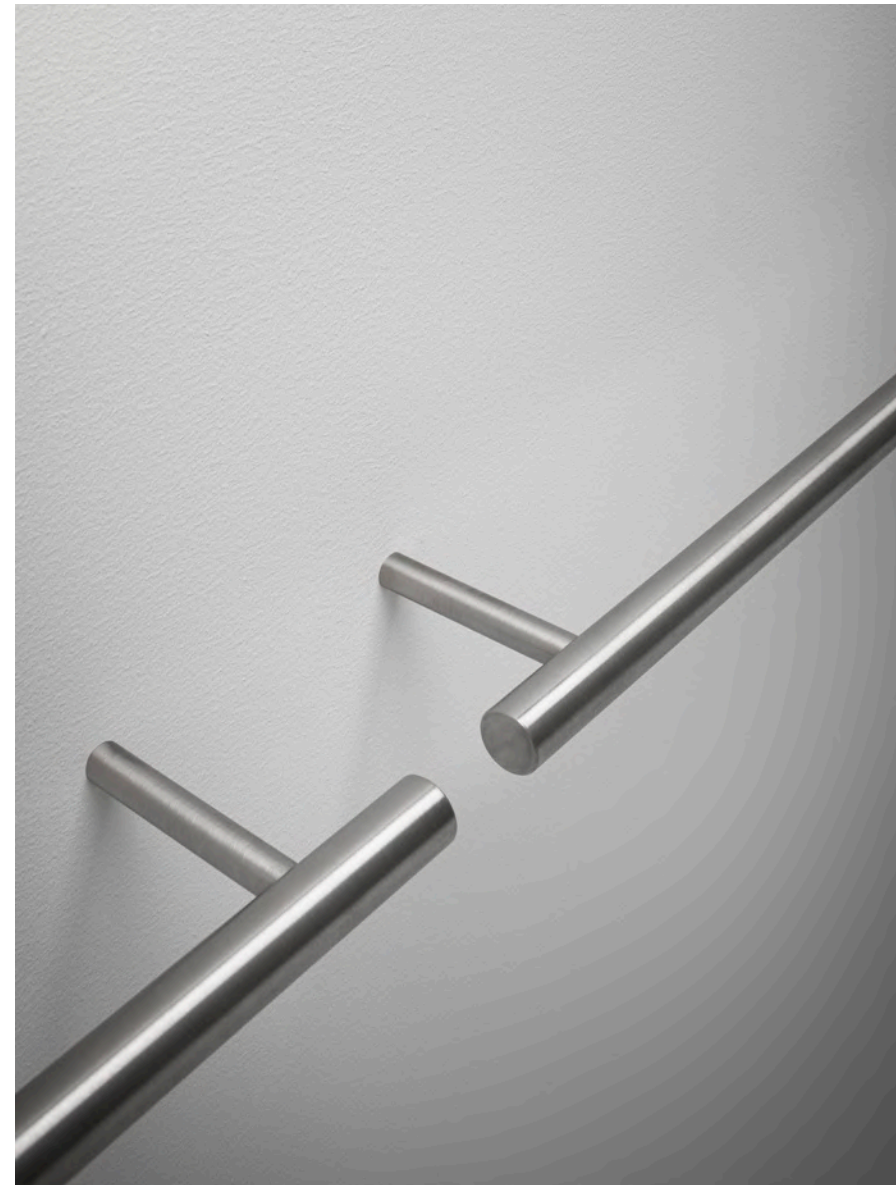

**FINITURE** | Finishes | Oberfläche | Finitions | Acabados



**SP**  
**Inox spazzolato**  
Brushed stainless steel  
Gebürstetes Edelstahl  
Acier inoxydable brossé  
Acero inoxidable cepillado



**SQ**  
**Inox spazzolato / Nero**  
Brushed stainless steel/Matt black  
Gebürstetes Edelstahl/Schwarz matt  
Acier inoxydable brossé/Noir mat  
Acero inoxidable cepillado/Negro mate

**Cat. 2**

**LEGNI** | Woods | Holz | Bois | Maderas



**R4**  
**Rovere**  
Oak  
Eiche  
Rouvre  
Roble



**RP**  
**Rovere sbiancato**  
Bleached oak  
Gebleichte Eiche  
Rouvre blanchi  
Roble blanqueado



**CG**  
**Canaletto grigio**  
Grey Canaletto  
Canaletto Grau  
Canaletto gris  
Canaletto gris

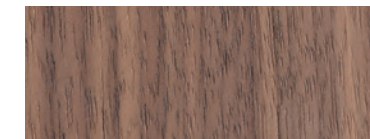

**N8**  
**Noce naturale**  
Natural walnut  
Nussbaum Natur  
Noyer naturel  
Nogal naturales

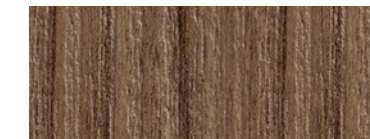

**NC**  
**Noce Canaletto**  
Canaletto walnut  
Nussbaum Canaletto  
Noyer Canaletto  
Nogal Canaletto



**N6**  
**Noce bruciato**  
Walnut burned  
Nussbaum gebrannt  
Noyer brûlé  
Nogal quemado

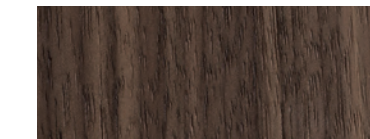

**NW**  
**Noce Brown**  
Walnut Brown  
Nussbaum Braun  
Noyer Foncé  
Nogal marrón

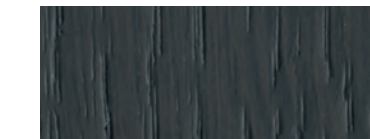

**RG**  
**Rovere grigio**  
Grey oak  
Eiche Grau  
Rouvre gris  
Roble gris

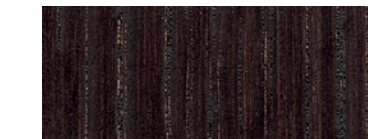

**W4**  
**Wengé**  
Wengé  
Wengé  
Wengé  
Wengué

**Cristalplant Biobased**



**00**  
**Bianco opaco**  
Matt white  
Weiss matt  
Blanc mat  
Blanco mate

## ACCESSORI CILINDRO | *Cilindro accessories*

Cilindro Zubehör | Accessoires Cilindro | Opcionales Cilindro

### PORTA SALVIETTE A PARETE DECENTRATO | Off-centred wall towel bar | Dezentralisierter Wandhandtuchhalter | Porte-serviette au mur décentralisé | Toallero a pared descentralizado



Versione DX | Right version

| Art.                   | P    | L  |
|------------------------|------|----|
| <b>GX5 DX • GX6 SX</b> | 10,4 | 60 |

**Materiale: Acciaio Inox** | Material: Steel  
Material: Stahl | Matériau: Acier | Material: Acero

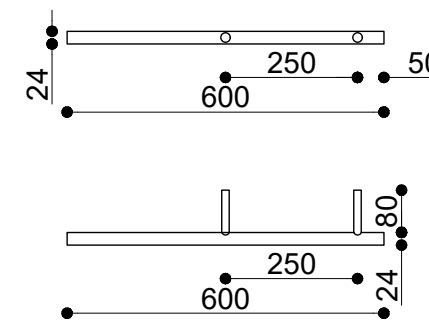

**Inox spazzolato**  
Brushed stainless steel  
**284**

**Inox spazzolato/nero opaco**  
Brushed stainless steel/matt black  
**294**

### MENSOLA PER PORTA SALVIETTE A PARETE DECENTRATO | Shelf for off-centred wall towel bar | Ablage für dezentralisierten Wandhandtuchhalter | Étagère porte-serviette au mur décentralisée | Repisa para toallero a pared descentralizado

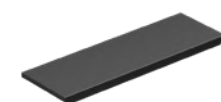

| Art.       | P   | L  |
|------------|-----|----|
| <b>GY7</b> | 7,8 | 25 |
| <b>GY8</b> | 7,8 | 25 |

**Mensola in massello di Noce o Rovere o Cristalplant** | Shelf in solid walnut, solid oak or Cristalplant | Ablage aus Massivnussbaum, Massiveiche oder Cristalplant | Étagère en bois massif de noyer ou rouvre ou Cristalplant | Repisa en nogal macizo, roble macizo o cristalplant

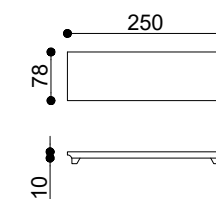

**Cat. 2**    **Cristalplant**

**113**

**69**

### MENSOLA CON DOSATORE SAPONE E BICCHIERE PER PORTA SALVIETTE A PARETE DECENTRATO | Shelf with soap dispenser and glass for off-centred wall towel bar | Ablage mit Seifenspender und Glas für dezentralisierten Wandhandtuchhalter | Étagère avec distributeur savon et verre pour porte-serviette au mur décentralisée | Repisa con jabonera y vaso para toallero a pared descentralizado



| Art.        | P   | L  |
|-------------|-----|----|
| <b>#B01</b> | 7,8 | 25 |
| <b>#B02</b> | 7,8 | 25 |

**Mensola in massello di Noce o Rovere o Cristalplant** | Shelf in solid walnut, solid oak or Cristalplant | Ablage aus Massivnussbaum, Massiveiche oder Cristalplant | Étagère en bois massif de noyer ou rouvre ou Cristalplant | Repisa en nogal macizo, roble macizo o cristalplant

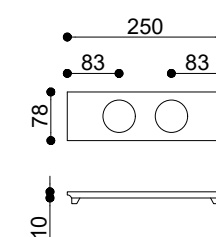

**Cat. 2**    **Cristalplant**

**429**

**390**

### COMPOSIZIONI | Compositions | Zusammensetzung | Compositions | Composicion

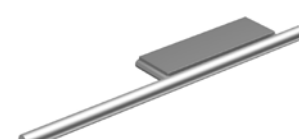

## ACCESSORI CILINDRO | *Cilindro accessories*

Cilindro Zubehöre | Accessoires Cilindro | Opcionales Cilindro

### PORTA SALVIETTE A PARETE | Wall towel bar | Wandhandtuchhalter | Porte-serviette au mur | Toallero a pared



| Art.       | P    | L  |
|------------|------|----|
| <b>GX3</b> | 10,4 | 60 |

**Materiale: Acciaio Inox** | Material: Steel  
Material: Stahl | Matériau: Acier | Material: Acero

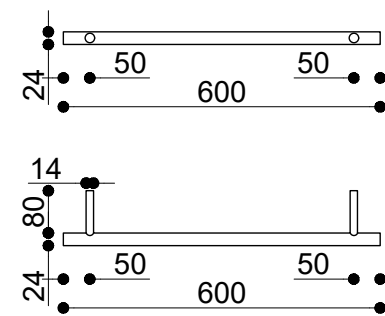

**Inox spazzolato**  
Brushed stainless steel  
**284**

**Inox spazzolato/nero opaco**  
Brushed stainless steel/matt black  
**294**

### MENSOLA PER PORTA SALVIETTE A PARETE | Shelf for wall towel bar | Ablage für Wandhandtuchhalter | Étagère porte-serviette au mur | Repisa para toallero a pared



| Art.       | P   | L  |
|------------|-----|----|
| <b>GY5</b> | 7,8 | 50 |
| <b>GY6</b> | 7,8 | 50 |

**Mensola in massello di Noce o Rovere o Cristalplant** | Shelf in solid walnut, solid oak or Cristalplant | Ablage aus Massivnussbaum, Massiveiche oder Cristalplant | Étagère en bois massif de noyer ou rouvre ou Cristalplant | Repisa en nogal macizo, roble macizo o cristalplant

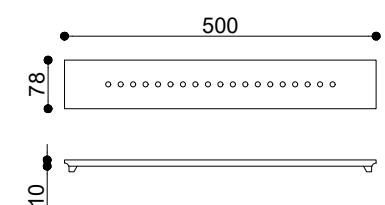

**Cat. 2**    **Cristalplant**

**170**

**98**

### MENSOLA CON DOSATORE SAPONE E BICCHIERE PER PORTA SALVIETTE A PARETE | Shelf with soap dispenser and glass for wall towel bar | Ablage mit Seifenspender und Glas für Wandhandtuchhalter | Étagère avec distributeur savon et verre pour porte-serviette au mur | Repisa con jabonera y vaso para toallero a pared



| Art.                     | P   | L  |
|--------------------------|-----|----|
| <b>#B03 DX • #B04 SX</b> | 7,8 | 50 |
| <b>#B05 DX • #B06 SX</b> | 7,8 | 50 |

**Mensola in massello di Noce o Rovere o Cristalplant** | Shelf in solid walnut, solid oak or Cristalplant | Ablage aus Massivnussbaum, Massiveiche oder Cristalplant | Étagère en bois massif de noyer ou rouvre ou Cristalplant | Repisa en nogal macizo, roble macizo o cristalplant

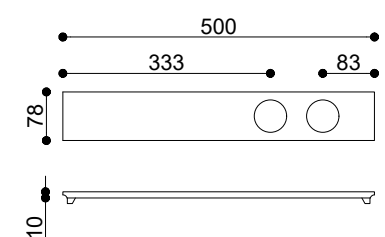

**Cat. 2**    **Cristalplant**

**486**

**425**

### COMPOSIZIONI | Compositions | Zusammensetzung | Compositions | Composicion

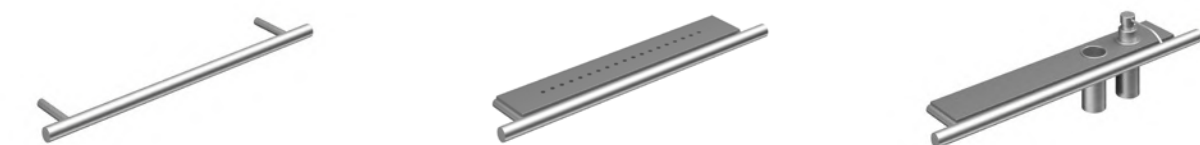

## ACCESSORI CILINDRO | *Cilindro accessories*

Cilindro Zubehöre | Accessoires Cilindro | Opcionales Cilindro

### PORTA SALVIETTE FREESTANDING | Freestanding towel holder | Freistehender Tuchhalter | Porte-serviette sur pied | Toallero en columna



| Art.       | P  | L  | H  |
|------------|----|----|----|
| <b>GX1</b> | 22 | 75 | 70 |

**Materiale: Acciaio Inox** | Material: Steel  
Material: Stahl | Matériau: Acier | Material: Acero

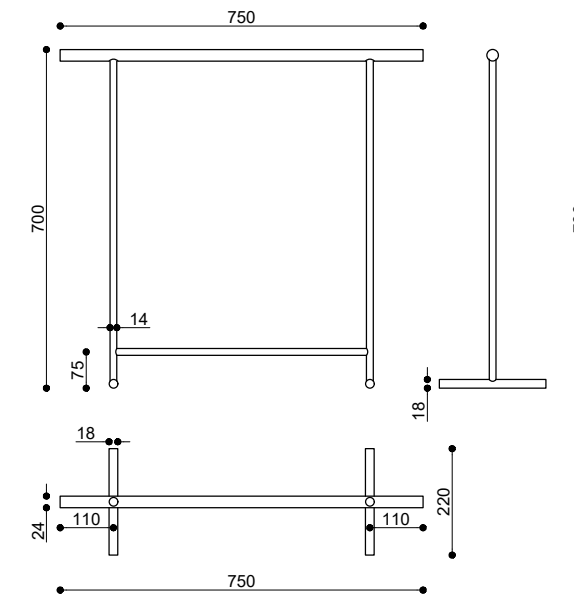

**Inox spazzolato**  
Brushed stainless steel  
**499**

**Inox spazzolato/nero opaco**  
Brushed stainless steel/matt black  
**520**

### PIASTRINA ACCIAIO PER PARETI MORBIDE | Steel plate for soft walls | Stahlplatte für weiche Wände | Assiette en acier pour mur souple | Placa de acero para paredes blandas



| Art.       | P | L | H   |
|------------|---|---|-----|
| <b>GZ8</b> | 2 | 2 | 0,3 |

**Materiale: Acciaio Inox** | Material: Steel  
Material: Stahl | Matériau: Acier | Material: Acero

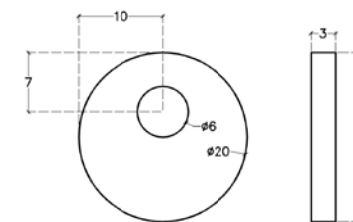

**Inox spazzolato**  
Brushed stainless steel  
**35\***

\* Prezzo per singolo articolo | Price for single item

### IDROSCOPINO | Hydrobrush | Hydrobrush | Hydro-brosse de toilette | Escobillero con chorro de agua



| Art.       | P   | L   | H    |
|------------|-----|-----|------|
| <b>GZ7</b> | 8,2 | 6,3 | 15,4 |

**Materiale: Acciaio Inox** | Material: Steel  
Material: Stahl | Matériau: Acier | Material: Acero

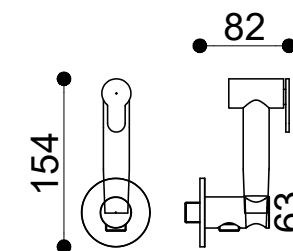

**Inox spazzolato**  
Brushed stainless steel  
**590**



## ACCESSORI CILINDRO | *Cilindro accessories*

Cilindro Zubehöre | Accessoires Cilindro | Opcionales Cilindro

### PORTA ROTOLO DA TERRA | Floorstanding toilet paper holder | Bodentoilettenpapierhalter | Porte-rouleau de papier toilette | Suporte de papel higiénico en columna



| Art.       | P | L | H  |
|------------|---|---|----|
| <b>GZ6</b> | 9 | 9 | 55 |

**Materiale: Acciaio Inox** | Material: Steel  
Material: Stahl | Matériau: Acier | Material: Acero

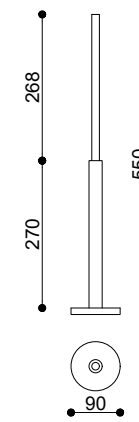

**Inox spazzolato**  
Brushed stainless steel  
**229**

**Inox spazzolato/nero opaco**  
Brushed stainless steel/matt black  
**239**

### PORTA SCOPINO DA TERRA | Floorstanding toilet brush holder | Bodenklobürste | Porte-brosse de toilette au sol | Escobillero en columna



| Art.       | P   | L   | H  |
|------------|-----|-----|----|
| <b>GZ3</b> | 6,4 | 6,4 | 55 |

**Materiale: Acciaio Inox** | Material: Steel  
Material: Stahl | Matériau: Acier | Material: Acero

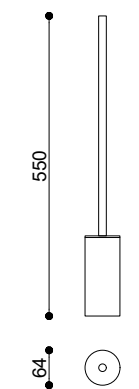

**Inox spazzolato**  
Brushed stainless steel  
**189**

**Inox spazzolato/nero opaco**  
Brushed stainless steel/matt black  
**199**

### PORTA SCOPINO A PARETE | Wall-mounted toilet brush holder | Wandmontierte Klobürste | Porte-brosse de toilette mural | Escobillero de pared



| Art.       | P   | L   | H  |
|------------|-----|-----|----|
| <b>GZ4</b> | 6,4 | 8,6 | 55 |

**Materiale: Acciaio Inox** | Material: Steel  
Material: Stahl | Matériau: Acier | Material: Acero

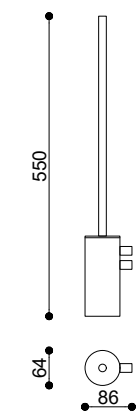

**Inox spazzolato**  
Brushed stainless steel  
**239**

**Inox spazzolato/nero opaco**  
Brushed stainless steel/matt black  
**249**



# PORTA RUBINETTI CILINDRO | *Cilindro tap holder*

Armaturenhalter | porte-robinets Cilindro | Suportes para griferia

**FINITURE** | Finishes | Oberfläche | Finitions | Acabados





## Cat. 1

**LACCATI OPACHI** | Matt painted | Matte Lackierung | Lacqué opaque | Laqueados opacos

|   |   |   |   |  |   |   |   |   |   |  |  |
|---|---|---|---|--|---|---|---|---|---|--|--|
|  |                        |  |                           |                           |  |                            |        |  |  |             |  |
| <b>B0</b><br><b>Bianco</b><br>White<br>Weiß<br>Blanc<br>Blanco                    | <b>GP</b><br><b>Grigio Pavillon</b><br>Pavillon grey<br>Pavillon Grau<br>Gris Pavillon<br>Gris Pavillon | <b>PI</b><br><b>Pioggia</b><br>Rain<br>Regen<br>Pluie<br>lluvia                   | <b>GL</b><br><b>Grigio Londra</b><br>London grey<br>London Grau<br>Gris Londres<br>Gris Londres             | <b>EY</b><br><b>Grigio Exclusive</b><br>Exclusive grey<br>Exclusive Grau<br>Gris Exclusive<br>Gris Exclusive | <b>GF</b><br><b>Grafite</b><br>Graphite<br>Graphit<br>Graphite<br>Grafito           | <b>N2</b><br><b>Nero</b><br>Black<br>Schwarz<br>Noir<br>Negro   | <b>G5</b><br><b>Grigio Bromo</b><br>Bromo grey<br>Bromo Grau<br>Gris Bromo<br>Gris Bromo  | <b>FA</b><br><b>Fango</b><br>Mud<br>Schlamm<br>Boue<br>Barro                        | <b>VI</b><br><b>Visone</b><br>Mink<br>Nerz<br>Vison<br>Vison                        | <b>AZ</b><br><b>Azzurro polvere</b><br>Blue powder<br>Blau Puder<br>Bleu poudre<br>Azul pálido |  |
|  |                        |  |                           |                           |  |                            |        |  |  |  |  |
| <b>CA</b><br><b>Canapa</b><br>Hemp<br>Hanf<br>Chanvre<br>Cáñamo                   | <b>S2</b><br><b>Sabbia</b><br>Sand<br>Sand<br>Sable<br>Arena  | <b>C2</b><br><b>Creta</b><br>Clay<br>Ton<br>Crête<br>Creta                        | <b>C7</b><br><b>Castoro Ottawa</b><br>Ottawa Beaver<br>Biber-Farbe Ottawa<br>Castor Ottawa<br>Castor Ottawa | <b>CD</b><br><b>Argilla</b><br>Argilla<br>Argilla<br>Argilla<br>Argilla                                      | <b>FE</b><br><b>Ferro</b><br>Iron<br>Eisen<br>Fer<br>Hierro                         | <b>V1</b><br><b>Verde Commodore</b><br>Green Commodore<br>Commodore Grün<br>Vert Commodore<br>Verde Commodoro | <b>V7</b><br><b>Verde Agave</b><br>Agave Green<br>Agave Grün<br>Vert Agave<br>Verde Agave | <b>AV</b><br><b>Avio</b><br>Aviation<br>Luftfahrt<br>Aviation<br>Aviación           | <b>B7</b><br><b>Blu Fes</b><br>Fes blue<br>Blau Fes<br>Bleu Fes<br>Azul Fes         |  |  |

## Cat. 2

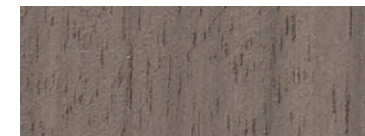
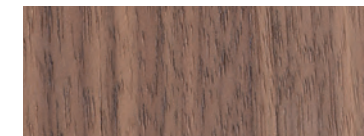
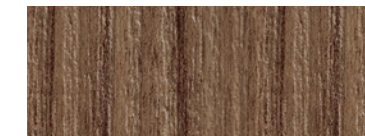
**LEGNI** | Woods | Holz | Bois | Maderas

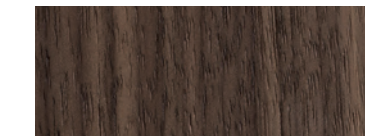
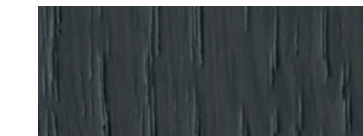
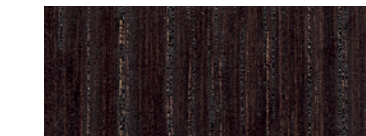
|   |  |  |  |   |  |   |   |  |   |
|---|--|--|--|---|--|---|---|--|---|
|  |                             |   |                          |                      |                               |                    |            |     |  |
| <b>R4</b><br><b>Rovere</b><br>Oak<br>Eiche<br>Rouvre<br>Roble                       | <b>RP</b><br><b>Rovere sbiancato</b><br>Bleached oak<br>Gebleichte Eiche<br>Rouvre blanchi<br>Roble blanqueado | <b>RK</b><br><b>Rovere Solid Skin</b><br>Solid Skin oak<br>Eiche "Solid Skin"<br>Rouvre "Solid Skin"<br>Roble "Solid Skin" | <b>CG</b><br><b>Canaletto grigio</b><br>Grey Canaletto<br>Canaletto Grau<br>Canaletto gris<br>Canaletto gris | <b>N8</b><br><b>Noce naturale</b><br>Natural walnut<br>Nussbaum Natur<br>Noyer naturel<br>Nogal naturales | <b>NC</b><br><b>Noce Canaletto</b><br>Canaletto walnut<br>Nussbaum Canaletto<br>Noyer Canaletto<br>Nogal Canaletto | <b>N6</b><br><b>Noce bruciato</b><br>Walnut burned<br>Nussbaum gebrannt<br>Noyer brûlé<br>Nogal quemado | <b>NW</b><br><b>Noce Brown</b><br>Walnut Brown<br>Nussbaum Braun<br>Noyer Foncé<br>Nogal marrón | <b>RG</b><br><b>Rovere grigio</b><br>Grey oak<br>Eiche Grau<br>Rouvre gris<br>Roble gris | <b>W4</b><br><b>Wengé</b><br>Wengé<br>Wengé<br>Wengé<br>Wengué                        |

**PORTA SALVIETTE IN ACCIAIO** | Inox steel towel holder | Edelstahlhandtuchhalter | Porte-serviette en acier | Toallero en acero

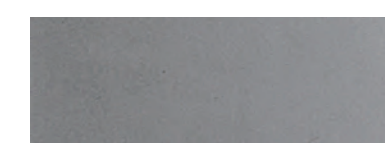

**SP**  
**Inox spazzolato**  
Brushed stainless steel  
Gebürstetes Edelstahl  
Acier inoxydable brossé  
Acero inoxidable cepillado

## PORTA RUBINETTI CILINDRO | *Cilindro tap holder*

Armaturenhalter | porte-robinets Cilindro | Suportes para griferia

### PORTA RUBINETTO A PARETE CON PORTA SALVIETTE PER LAVABO FREESTANDING | Wall tap holder with towel bar for freestanding basin | Hahnwandhalter mit Tuchhalter für freistehendes Becken | Porte-robinet au mur avec porte-serviette pour lavabo sur pied | Suporte para grifo a pared con toallero para lavabo en columna



Versione DX | Right version

| Art.                   | P   | L  | H  |
|------------------------|-----|----|----|
| <b>GX7 DX • GX8 SX</b> | 7,8 | 60 | 93 |

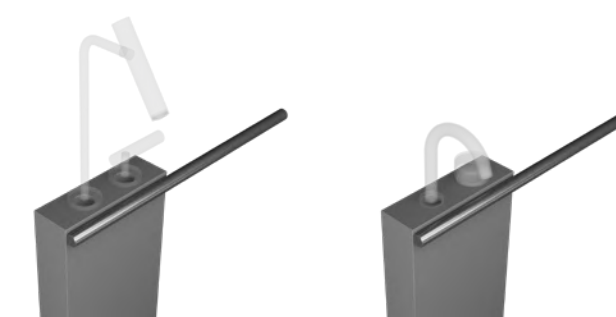
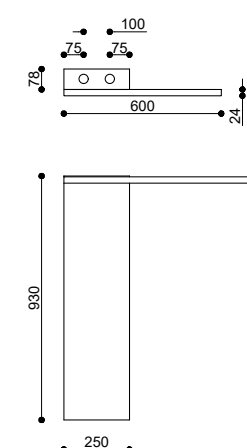

**Porta rubinetteria compatibile con serie acquifero e cilindro** | Tap holder compatible with acquifero and cilindro taps | Hahnhalter kompatibel mit acquifero- und cilindroarmaturen | Porte-robinets compatible avec les séries acquifero et cilindro | Suporte para griferia compatible con grifos acquifero y cilindro

| Cat.1 | Cat.2 |
|-------|-------|
| 749   | 829   |

### PORTA RUBINETTO A PAVIMENTO CON PORTA SALVIETTE PER VASCA | Floor standing tap holder with towel bar for bathtub | Bodenstehender Hahnhalter mit Tuchhalter für Badewanne | Porte-robinet au sol avec porte-serviette pour baignoire | Suporte para grifo en columna con toallero para bañera

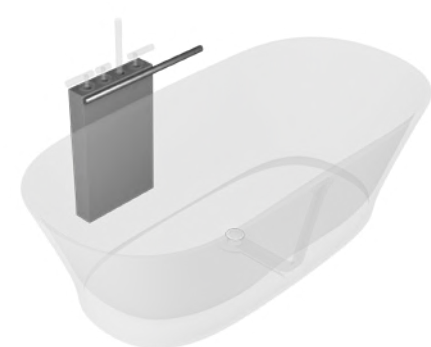

Versione DX | Right version

| Art.                   | P   | L  | H  |
|------------------------|-----|----|----|
| <b>GZ1 DX • GZ2 SX</b> | 7,8 | 80 | 56 |

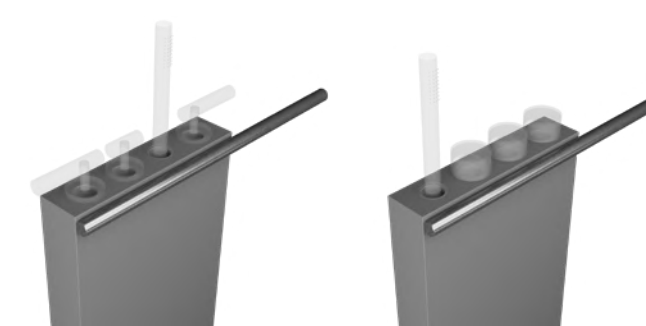
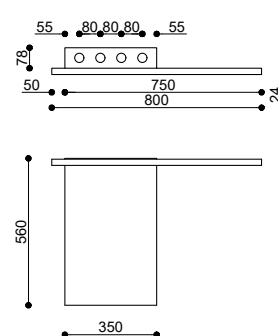

**Porta rubinetteria compatibile con serie acquifero e cilindro** | Tap holder compatible with acquifero and cilindro taps | Hahnhalter kompatibel mit acquifero- und cilindroarmaturen | Porte-robinets compatible avec les séries acquifero et cilindro | Suporte para griferia compatible con grifos acquifero y cilindro

| Cat.1 | Cat.2 |
|-------|-------|
| 839   | 939   |

### OPTIONAL RUBINETTO D'ARRESTO | Optional shut-off valve | Option Absperrhahn | Option vanne d'arrêt | Opcional valvula cierre

Art.

**GXS**

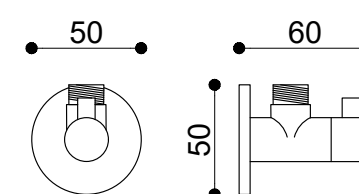

**Materiale: Acciaio Inox** | Material: Steel  
Material: Stahl | Matériau: Acier | Material: Acero

179

FONTANA LAVABO DA TERRA | Fontana *freestanding basin*  
Fontana freistehendes Waschbecken | Fontana lavabo à colonne | Fontana lavabo en columna



## FONTANA LAVABO DA TERRA | Fontana *freestanding basin*

Fontana freistehendes Waschbecken | Fontana lavabo à colonne | Fontana lavabo en columna

**FINITURE** | Finishes | Oberfläche | Finitions | Acabados

### **Cristalplant Biobased**



00

**Bianco opaco**

Matt white

Weiss matt

Blanc mat

Blanco mate

FONTANA LAVABO DA TERRA | Fontana *freestanding basin*  
 Fontana freistehendes Waschbecken | Fontana lavabo à colonne | Fontana lavabo en columna

**LAVABO FREESTANDING IN CRISTALPLANT BIOBASED** | Freestanding washbasin in Cristalplant Biobased | Freistehendes waschbecken aus Cristalplant Biobased | Lavabo sur pied en Cristalplant Biobased | Lavabo freestanding en Cristalplant Biobased

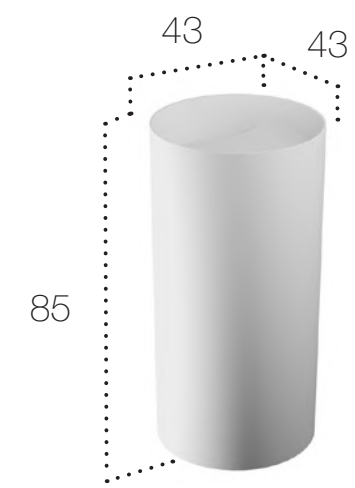

|            |    |    |    |
|------------|----|----|----|
| Art.       | P  | L  | H  |
| <b>WF4</b> | 43 | 43 | 85 |

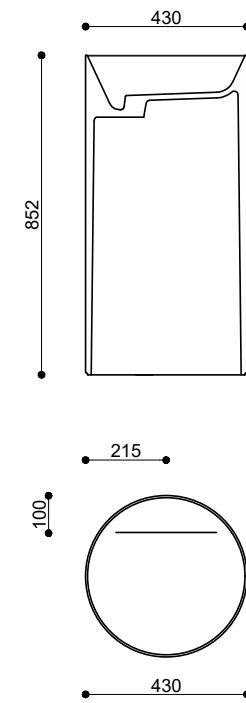

**Bianco opaco**  
 Matt white  
**2.225**

**Accessori compresi** | Included accessories

|                           |                                |
|---------------------------|--------------------------------|
| <b>Piletta</b>   Waste    | <b>Troppo pieno</b> / Overflow |
| <b>Inclusa</b>   Included | <b>No</b>                      |

**Accessori suggeriti** | Suggested accessories

|                      |
|----------------------|
| <b>Sifone</b>   Trap |
| <b>52R + 54U</b>     |

**PASSEPARTOUT PER RACCORDO SIFONE** | Passepartout for waste joint siphons | Passepartout für Anschluss an Geruchverschluss | Passepartout pour raccord à siphon | Passepartout para roscar a sifón

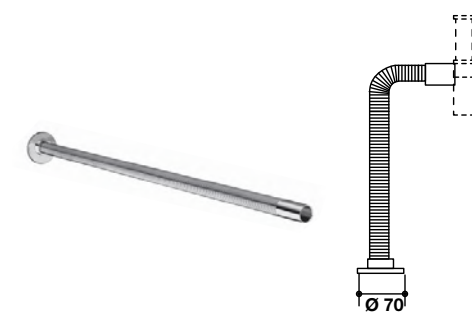

|            |
|------------|
| Art.       |
| <b>52R</b> |

**Acciaio**  
 Steel  
**163**

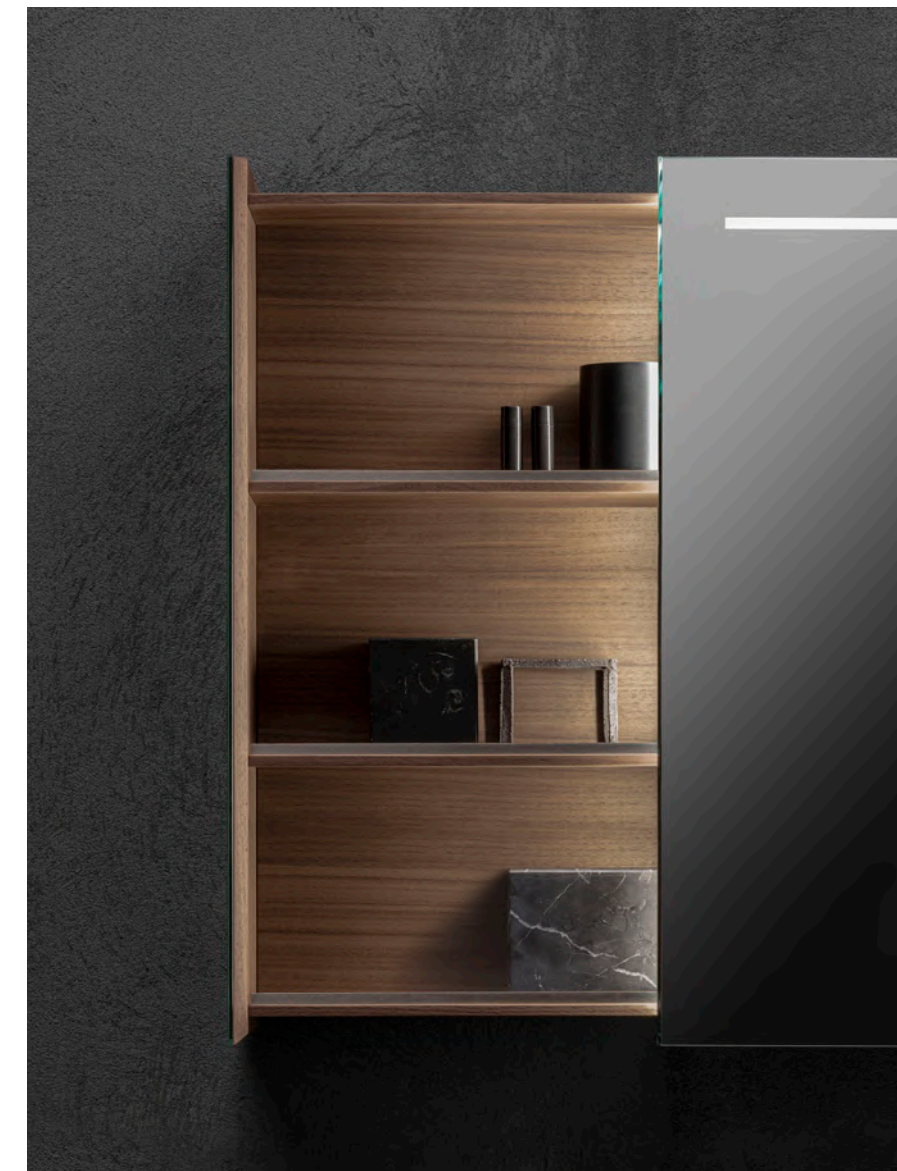



# SPECCHI CONTENITORI CON VANO ESTRAIBILE E ILLUMINAZIONE | *Mirror cabinets with lighting*

Spiegelschränke mit Beleuchtung | Armoires de toilette avec éclairage | Espejos contenedores con luz

**FINITURE** | Finishes | Oberfläche | Finitions | Acabados







## Cat. 1

**LACCATI OPACHI** | Matt painted | Matte Lackierung | Lacqué opaque | Laqueados opacos

|   |   |   |   |  |   |   |   |   |   |  |
|---|---|---|---|--|---|---|---|---|---|--|
|  |                        |  |                           |                           |  |                            |        |  |  |             |
| <b>B0</b><br><b>Bianco</b><br>White<br>Weiß<br>Blanc<br>Blanco                    | <b>GP</b><br><b>Grigio Pavillon</b><br>Pavillon grey<br>Pavillon Grau<br>Gris Pavillon<br>Gris Pavillon | <b>PI</b><br><b>Pioggia</b><br>Rain<br>Regen<br>Pluie<br>Iluvia                   | <b>GL</b><br><b>Grigio Londra</b><br>London grey<br>London Grau<br>Gris Londres<br>Gris Londres             | <b>EY</b><br><b>Grigio Exclusive</b><br>Exclusive grey<br>Exclusive Grau<br>Gris Exclusive<br>Gris Exclusive | <b>GF</b><br><b>Grafite</b><br>Graphite<br>Graphit<br>Graphite<br>Grafito           | <b>N2</b><br><b>Nero</b><br>Black<br>Schwarz<br>Noir<br>Negro   | <b>G5</b><br><b>Grigio Bromo</b><br>Bromo grey<br>Bromo Grau<br>Gris Bromo<br>Gris Bromo  | <b>FA</b><br><b>Fango</b><br>Mud<br>Schlamm<br>Boue<br>Barro                        | <b>VI</b><br><b>Visone</b><br>Mink<br>Nerz<br>Vison<br>Vison                        | <b>AZ</b><br><b>Azzurro polvere</b><br>Blue powder<br>Blau Puder<br>Bleu poudre<br>Azul pálido |
|  |                        |  |                           |                           |  |                            |        |  |  |  |
| <b>CA</b><br><b>Canapa</b><br>Hemp<br>Hanf<br>Chanvre<br>Cáñamo                   | <b>S2</b><br><b>Sabbia</b><br>Sand<br>Sand<br>Sable<br>Arena  | <b>C2</b><br><b>Creta</b><br>Clay<br>Ton<br>Crête<br>Creta                        | <b>C7</b><br><b>Castoro Ottawa</b><br>Ottawa Beaver<br>Biber-Farbe Ottawa<br>Castor Ottawa<br>Castor Ottawa | <b>CD</b><br><b>Argilla</b><br>Argilla<br>Argilla<br>Argilla<br>Argilla                                      | <b>FE</b><br><b>Ferro</b><br>Iron<br>Eisen<br>Fer<br>Hierro                         | <b>V1</b><br><b>Verde Commodore</b><br>Green Commodore<br>Commodore Grün<br>Vert Commodore<br>Verde Commodore | <b>V7</b><br><b>Verde Agave</b><br>Agave Green<br>Agave Grün<br>Vert Agave<br>Verde Agave | <b>AV</b><br><b>Avio</b><br>Aviation<br>Luftfahrt<br>Aviation<br>Aviación           | <b>B7</b><br><b>Blu Fes</b><br>Fes blue<br>Blau Fes<br>Bleu Fes<br>Azul Fes         |  |

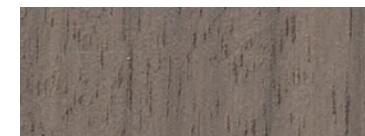
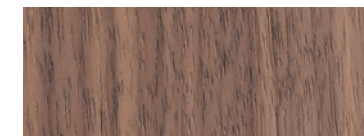
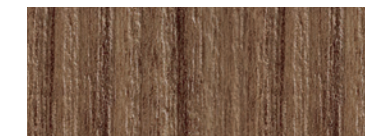
## Cat. 2

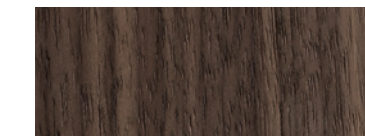
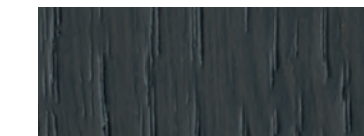
**LEGNI** | Woods | Holz | Bois | Maderas

|   |  |  |  |   |  |   |   |  |   |
|---|--|--|--|---|--|---|---|--|---|
|  |                             |   |                          |                      |                               |                    |            |     |  |
| <b>R4</b><br><b>Rovere</b><br>Oak<br>Eiche<br>Rouvre<br>Roble                       | <b>RP</b><br><b>Rovere sbiancato</b><br>Bleached oak<br>Gebleichte Eiche<br>Rouvre blanchi<br>Roble blanqueado | <b>RK</b><br><b>Rovere Solid Skin</b><br>Solid Skin oak<br>Eiche "Solid Skin"<br>Rouvre "Solid Skin"<br>Roble "Solid Skin" | <b>CG</b><br><b>Canaletto grigio</b><br>Grey Canaletto<br>Canaletto Grau<br>Canaletto gris<br>Canaletto gris | <b>N8</b><br><b>Noce naturale</b><br>Natural walnut<br>Nussbaum Natur<br>Noyer naturel<br>Nogal naturales | <b>NC</b><br><b>Noce Canaletto</b><br>Canaletto walnut<br>Nussbaum Canaletto<br>Noyer Canaletto<br>Nogal Canaletto | <b>N6</b><br><b>Noce bruciato</b><br>Walnut burned<br>Nussbaum gebrannt<br>Noyer brûlé<br>Nogal quemado | <b>NW</b><br><b>Noce Brown</b><br>Walnut Brown<br>Nussbaum Braun<br>Noyer Foncé<br>Nogal marrón | <b>RG</b><br><b>Rovere grigio</b><br>Grey oak<br>Eiche Grau<br>Rouvre gris<br>Roble gris | <b>W4</b><br><b>Wengé</b><br>Wengé<br>Wengé<br>Wengé<br>Wengué                        |

## SPECCHI CONTENITORI CON VANO ESTRAIBILE E ILLUMINAZIONE | *Mirror cabinets with lighting*

Spiegelschränke mit Beleuchtung | Armoires de toilette avec éclairage | Espejos contenedores con luz

### SPECCHI CONTENITORI CON ILLUMINAZIONE INTERNA E VANO ESTRAIBILE LATERALE | Cabinet mirror with internal lighting and pull-out compartment | Spiegelschränke mit interner Beleuchtung und ausziehbarem Fach | Armoire de toilette avec 'éclairage intérieur et compartiment extractible | Espejos contenedores con luz interior y compartimento extraíbles

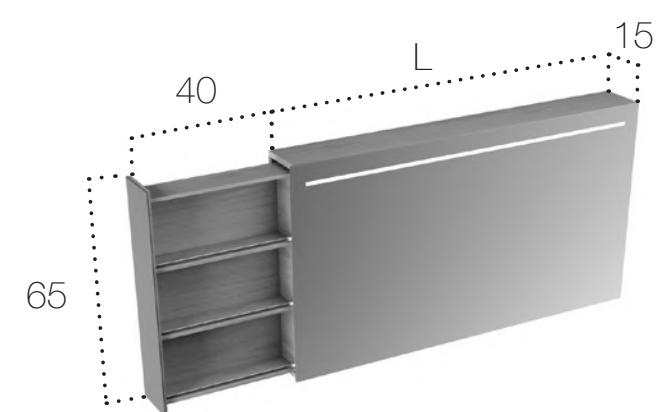

Versione SX | Left version

| Art.                           | P  | L   | H  |
|--------------------------------|----|-----|----|
| <b>ZPA 80 DX • ZPB 80 SX</b>   | 15 | 80  | 65 |
| <b>ZPA 100 DX • ZPB 100 SX</b> | 15 | 100 | 65 |
| <b>ZPA 120 DX • ZPB 120 SX</b> | 15 | 120 | 65 |

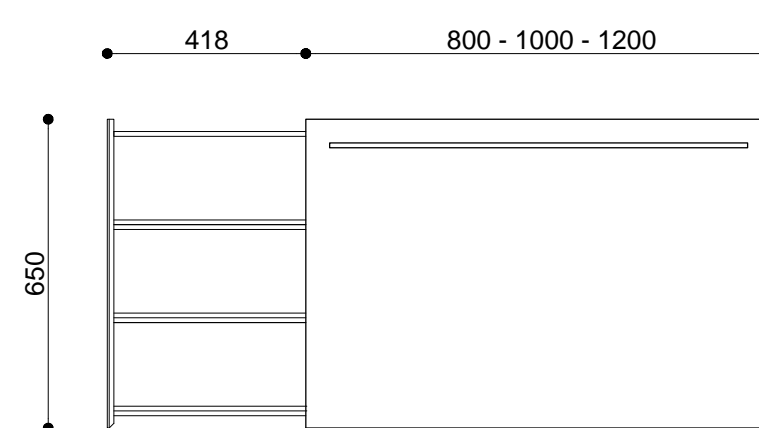

Versione SX | Left version

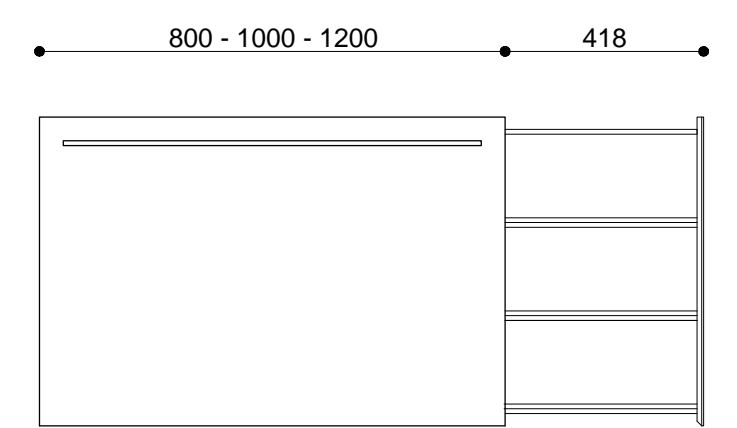

Versione DX | Right version

| Cat.1        | Cat.2        |
|--------------|--------------|
| <b>1.920</b> | <b>2.090</b> |
| <b>1.990</b> | <b>2.180</b> |
| <b>2.090</b> | <b>2.280</b> |

### OPTIONAL PRESA ELETTRICA + 2 PRESE USB CON CABLAGGIO | Optional electrical outlet + 2 usb sockets with wiring | Optional Stromsteckdose + Usb-Anschlüsse mit Verkabelung | Option prise électrique + 2 prise usb avec câblage Opcional enchufe eléctrico + 2 tomas usb con cableado



Art.

**Q83 DX • Q84 SX**  
**Q86 DX • Q87 SX**

Con presa elettrica svizzera | CH outlet  
Mit CH Stromsteckdose | Avec prise électrique  
Suisse | Opcional enchufe eléctrico suizo

|             |            |
|-------------|------------|
| Cad. / Each | <b>394</b> |
| Cad. / Each | <b>394</b> |

### OPTIONAL DOPPIA PRESA ELETTRICA CON CABLAGGIO | Optional two electrical outlet with wiring | Optional Doppelstromsteckdose mit Verkabelung | Option double prise électrique avec câblage | Opcional doble enchufe eléctrico con cableado



Art.

**Q81 DX • Q82 SX**  
**Q93 DX • Q94 SX**

Con presa elettrica svizzera | CH outlet  
Mit CH Stromsteckdose | Avec prise électrique  
Suisse | Opcional enchufe eléctrico suizo

|             |            |
|-------------|------------|
| Cad. / Each | <b>294</b> |
| Cad. / Each | <b>294</b> |

- I prezzi si intendono Iva esclusa, franco ns/Stabilimento.
  - I termini previsti per l'approntamento e la consegna non sono da intendere come essenziali e saranno indicati nell'Accettazione d'Ordine; sono in ogni caso fatti salvi i ritardi sui quali abbiano influito cause di forza maggiore o, comunque cause non pienamente imputabili alla Venditrice. È convenuto, comunque, che nessun ritardo potrà dar diritto al Compratore a risarcimento danni o a risoluzioni del contratto. La consegna dei prodotti potrà anche avvenire mediante consegne successive parziali.
  - La merce viaggia sempre a rischio e pericolo dell'acquirente anche se venduta franco destino. L'acquirente è tenuto a controllare la merce in arrivo contestando eventuali danni o manomissioni degli imballi al momento dello scarico, indicando "l'accettazione con riserva" sul documento di trasporto e comunicando alla Falper l'entità degli eventuali danni entro 8 giorni a mezzo lettera raccomandata.
  - Non saranno evasi ordini inferiori a € 105,00 netti, che verranno comunque tenuti in considerazione in attesa di eventuali aggiunte. Da quanto sopra restano esclusi eventuali pezzi di ricambio.
  - L'eventuale resa della merce sarà accettata solo se preventivamente autorizzata dalla ns/Direzione e dovrà comunque pervenire in Porto Franco ai ns/Stabilimenti di Ozzano. In ogni caso i resi saranno gravati del 20% per spese generali, oltre ad eventuali altre spese dovute all'incuria del Cliente.
  - Particolari imballi in legno o pallets eventualmente necessari saranno fatturati al costo.
  - La FALPER si riserva il diritto di apportare ai propri modelli le modifiche tecniche ed estetiche che si rendessero necessarie senza preavviso alcuno.
  - Per qualsiasi controversia relativa al presente accordo fra le Parti e/o ai singoli contratti di compravendita, è esclusivamente competente il foro di Bologna rinunciando espressamente il Compratore alla competenza di altri Fori, anche a titolo di connessione.
  - Le suddette condizioni si intendono accettate integralmente contestualmente al ricevimento dell'ordine.
- 
- Prices are intended Iva Excluded, free our factory.
  - Foreseen terms for the production and the delivery are not to be intended as essential and will be indicated in the order acceptance; the delays owing to a cause beyond control or to a cause not entirely imputable to the seller, are to be considered safe. It was agreed anyway, that any delay will not give to the buyer the right of asking for a compensation for damages or for cancellation of a contract. The goods delivery could take place through partial subsequent deliveries.
  - Although delivery is free of charge, goods are despatched at the risk of the buyer. the buyer must check the goods on arrival and any packaging damage or tampering must be reported at the time they are unloaded. indicate "accepted with reservation" on the packing list and within 8 days inform Falper about the damage by registered letter.
  - The Company is forced to accept only orders whose value exceeds € 105,00 (with the exception of orders for spare parts). Orders received and complying with be prepared and held in case additional articles should be required.
  - The eventual returned of the goods will be accepted only if previously authorized from our direction and will have to arrive at our factory in Ozzano with carriage paid. However the returned will be burdened with 20% for general expenses with also eventual other expenses due to customer's carelessness.
  - Particular wooden packings or pallets eventually needed will be invoiced at cost.
  - FALPER reserves it self the right to make some technic and aesthetic changes that could result necessary for technical reasons in its models without any notice.
  - For each controversy relative to the present concordance between the parts and/or to the single buying and selling contracts, is exclusively competent the Bologna Court.
  - The above-mentioned conditions are intended as fully accepted with the order conferment.

- Die Preise verstehen sich ausschließlich Mehrwertsteuer, frei ab Werk.
  - Die Bereitstellungs- und Lieferfristen dürfen nicht als grundlegend verstanden werden, sie werden bei Annahme des Auftrags angegeben; auf keinen Fall sind diese jedoch bei Verspätungen, die Fällen von höherer Gewalt oder Ursachen, die nicht eindeutig der Verkäuferfirma zuzuschreiben sind, bindend. Es wird hiermit vereinbart, daß keine Verspätung den Käufer dazu berechtigt, Schadenersatz oder eine Vertragsauflösung zu verlangen. Die Lieferung der Produkte kann auch in Form von verschiedenen Teillieferungen erfolgen.
  - Der Versand erfolgt stets auf Risiko und Gefahr des Käufers, auch wenn die Ware frei Bestimmungsort verkauft wurde. Der Käufer ist verpflichtet die ankommenden Waren zu kontrollieren und eventuelle Schäden oder ein Aufbrechen von Verpackung bei der Lieferung sofort zu beanstanden. Dazu muss der Vermerk "Warenannahme unter Vorbehalt" auf dem Lieferschein angegeben werden. Eventuelle Schäden müssen außerdem innerhalb von 8 Tagen der Firma Falper per Einschreiben mitgeteilt werden.
  - Aufträge, deren Gesamtpreis unter € 105,00 netto liegt, werden nicht ausgeführt, jedoch in Erwartung von eventuellen Zusatzaufträgen bereitgehalten. Davon sind Ersatzteilbestellungen ausgenommen.
  - Eine eventuelle Warenrücksendung wird nur dann akzeptiert, wenn sie zuvor von unserer Geschäftsleitung bewilligt worden ist. Die Waren müssen frachtfrei in unser Werk in Ozzano gesandt werden. Auf die zurückgesandten Waren werden 20% für allgemeine Kosten berechnet, sowie eventuell weitere Kosten, falls der Kunde unvorsichtig gehandelt hat.
  - Spezielle Verpackungen aus Holz oder eventuell notwendige Paletten werden zum Kostenpreis verrechnet.
  - FALPER behält sich das Recht vor, ohne vorherige Benachrichtigung auf ihren Modellen technische oder das Aussehen betreffende Veränderungen anzubringen, falls diese notwendig sind.
  - Falls in Verbindung mit dieser Vereinbarung und/oder den einzelnen Verkaufsverträgen zwischen den Handelspartnern Rechtsstreite entstehen sollten, ist nur das Gericht von Bologna zuständig, wobei der Käufer ausdrücklich darauf verzichtet, sich an andere Gerichte zu wenden, auch im Falle von Konnexität.
  - Die oben aufgeführten Bedingungen gelten bei Eingang des Auftrags als vollständig angenommen.
- 
- Les prix n'incluent pas la TVA et sont franco notre établissement.
  - Les délais prévus pour la préparation et la livraison sont primordiaux et seront indiqués sur le bon de commande; les retards dus pour causes de force majeure ou, dans tous les cas, dont le vendeur n'est pas complètement considéré responsable sont cependant exclus. On convient toutefois qu'aucun retard ne donnera à l'acheteur le droit d'être indemnisé pour les dommages ou résilier le contrat. La livraison des produits pourra également avoir lieu en plusieurs livraisons successives partielles.
  - La marchandise voyage toujours au risque et péril de l'acheteur, même dans le cas de ventes franco destination. L'acheteur est tenu de contrôler la marchandise à son arrivée et de signaler les dommages et les détériorations des emballages au moment du déchargement, en formulant des "réserves" sur le bulletin de livraison et en communiquant à Falper l'ampleur des dommages éventuels, dans un délai de 8 jours, par courrier recommandé.
  - Les commandes inférieures à € 105,00 au net ne seront pas exécutées et seront cependant tenues en considération dans l'attente de suppléments éventuels. Les pièces de rechange éventuelles sont bien sûr exclues.
  - Le retour éventuel de la marchandise ne sera accepté qu'après autorisation préalable de notre direction et devra cependant parvenir franc de port auprès de nos établissements d'Ozzano. Dans tous les cas, on appliquera une augmentation de 20% pour les frais généraux sur la marchandise rendue, outre à des frais éventuels dus à la négligence du client.
  - Des emballages particuliers nécessaires en bois ou palettes seront facturés selon leur coût.
  - La société Falper se réserve le droit de modifier sans préavis ses propres modèles en cas de nécessité du point de vue technique ou esthétique.
  - Pour tout litige concernant le présent accord entre les parties et /ou les contrats de vente individuels, la compétence sera exclusivement du tribunal de Bologne et l'acheteur devra expressément renoncer à d'autres tribunaux, ne serait-ce qu'à titre de simple liaison.
  - On considère que les conditions ci-dessus sont intégralement acceptées simultanément à l'arrivée de la commande.

- Los precios son IVA excluida, franco nuestro establecimiento.
- Los plazos previstos para la preparación y la entrega no deben ser considerados como esenciales y serán indicados en la Aceptación del Pedido; salvo, de todos modos, los retrasos en los que pudieren influir causas de fuerza mayor o, por cualquier otra causa no plenamente imputable a la Vendedora. Se conviene, de todos modos, que ningún retraso podrá dar derecho al Comprador al resarcimiento de daños o a resolución del contrato. La entrega de los productos podrá efectuarse mediante entregas sucesivas y parciales.
- La mercancía se transporta siempre a riesgo y peligro del comprador incluso cuando haya sido vendida franco destino. El comprador tiene que controlar la mercancía al recibirla reclamando eventuales daños o alteraciones de los embalajes al descargar, indicando "la aceptación con reserva" en el albarán de entrega o documento de porte y comunicando a Falper la importancia de los daños dentro de 8 días por carta certificada.
- No se despacharán pedidos inferiores a € 105,00 netos, que de todos modos se tendrán en consideración en espera de eventuales aumentos del pedido. Por todo lo antes expuesto se excluyen eventuales piezas de recambio.
- La mercancía devuelta será aceptada sólo si hubiera sido previamente autorizada por nuestra Dirección y tendrá que enviarse con porte pagado a nuestro establecimiento de Ozzano. De todos modos la mercancía sufrirá un aumento del 20% por gastos generales, además de cualquier otro gasto debido al descuido del Cliente.
- Embalajes especiales de madera o palets eventualmente necesarios serán facturadas al costo.
- FALPER se reserva el derecho de aportar las modificaciones técnicas y estéticas a sus propios modelos, que pudieran ser necesarias, sin previo aviso.
- Por cualquier controversia relativa al presente acuerdo entre las Partes y/o a cada contrato de compraventa, es exclusivamente competente el fuero de Bolonia renunciando expresamente el Comprador a la competencia de otros Tribunales, incluso a título de conexión.
- Las condiciones citadas se consideran aceptadas integral y contextualmente al recibir el pedido.

**falper.**

[falper.it](http://falper.it)